

UBC Social Ecological Economic Development Studies (SEEDS) Sustainability Program

Student Research Report

SPIRAL DRAIN REPLACEMENT

Delton Breckenridge, Gerald Epp, Keith Russell, Michael Veerman, Lindsey Waugh and Chris Wickman

University of British Columbia

CIVL 446

April 7, 2017



Disclaimer: "UBC SEEDS Sustainability Program provides students with the opportunity to share the findings of their studies, as well as their opinions, conclusions and recommendations with the UBC community. The reader should bear in mind that this is a student research project/report and is not an official document of UBC. Furthermore, readers should bear in mind that these reports may not reflect the current status of activities at UBC. We urge you to contact the research persons mentioned in a report or the SEEDS Sustainability Program representative about the current status of the subject matter of a project/report".

Executive Summary

In September 2016, the University of British Columbia (UBC) brought forth the concept of addressing their stormwater management needs in the North Catchment area. This catchment is drained via a spiral drain, which does not meet the desired 1:100 year and 1:200 year storm loads. Increasing the stormwater capacity through the spiral drain is imperative to reduce the risk of stormwater related damage to adjacent buildings and infrastructure. This includes maintaining slope stability in the seaside cliffs, as they are historically unstable.

In response to the University of British Columbia's (UBC) requested proposal to address stormwater management needs, Team 19 is proposing the construction of a multi-level parking facility at the north end of UBC campus. The parking facility will feature a dedicated lower level reservoir to address the relatively low capacity of the spiral drain by attenuating the peak flows through a simple passive storage concept while the basement level of the parkade will serve as a contingency storage reservoir. The structure of the facility is comprised of a concrete foundation with glulam and cross-laminated timber superstructure and green roof to reflect sustainability initiatives advocated by UBC. The hydrotechnical, structural and geotechnical design aspects for the structure were analyzed in accordance with the site and utility locations throughout the project site.

This report discusses the detailed design process for this project and includes detailed design drawings as well as 3D BIM (building information model) images. A detailed cost estimate analysis is also included.

April 7, 2017

Mr. Doug Doyle, P.Eng.
Doug Doyle, Associate Director, Municipal Engineering
University of British Columbia

Dear Mr. Doyle,

We are pleased to submit our Final Design Report for the Spiral Drain Replacement project, in response to your request for proposals. This report outlines our proposed detailed design and construction plan for this UBC project.

We believe that our proposal meets your desired design criteria and constraints, and offers an efficient solution for the north catchment area of UBC. Please do not hesitate to contact us at anytime regarding questions or comments.

We look forward to hearing any feedback you may have.

Sincerely,
Team 19

Delton Breckenridge

Gerald Epp

Keith Russell

Michael Veerman

Lindsey Waugh

Chris Wickman

Encl.

Table of Contents

| | |
|---|----|
| Executive Summary | 2 |
| 1.0 Project Overview | 6 |
| 1.1 Project Objectives | 6 |
| 1.2 Site Description | 7 |
| 1.3 Building Information Modeling (BIM) of Proposed Structure | 8 |
| 1.4 Site Requirements Regarding Existing Infrastructure | 9 |
| 1.5 Stakeholders | 10 |
| 2.0 Hydrotechnical | 12 |
| 3.0 Structural | 14 |
| 3.1 Loading | 14 |
| 3.2 Structural Design | 17 |
| 3.2.1 Reservoir Level | 17 |
| 3.2.2 Basement Level | 19 |
| 3.2.3 Ground Level | 20 |
| 3.3 Green Roof | 24 |
| 4.0 Geotechnical | 25 |
| 5.0 General Project Requirements | 27 |
| 5.1 Project Milestone Schedule | 27 |
| 5.2 Project Costs | 27 |
| 5.2.1 Cost Estimate Summary | 27 |
| 5.2.2 Scope of Estimate | 29 |
| 5.2.3 Lifecycle Cost Analysis | 30 |
| 5.3 Environmental Impact | 31 |
| 5.4 Maintenance | 32 |
| 5.5 Rehabilitation of Spiral Drain | 32 |
| 5.6 Future Policy and Development | 33 |
| 6.0 Conclusion | 34 |
| References | 35 |
| Appendices | 38 |
| Appendix A: Group Project Distribution | 38 |

| | |
|--|----|
| Appendix B: BIM Model Views (following pages) | 39 |
| Appendix C: Services Plan View (following page) | 44 |
| Appendix D: Topographic Plan (following page) | 46 |
| Appendix E: Structural Calculations (following pages) | 48 |
| Appendix F: Geotechnical Calculations | 59 |
| Appendix G: Project Milestone Schedule | 60 |
| Appendix H: Project Detailed Cost Estimate (following pages) | 62 |

List of Tables

| | |
|---|----|
| Table 1: Factored Loading for Structural Elements | 15 |
| Table 2: Project Cost Breakdown | 28 |
| Table 3: Overview of Annual O&M Costs and Parking Revenues..... | 30 |
| Table 4: Project Payback Period | 31 |

List of Figures

| | |
|--|----|
| Figure 1: Spiral Drain Location..... | 7 |
| Figure 2: Overall exterior 3D view of parking garage structure | 8 |
| Figure 3: Close-up exterior 3D view of parking garage structure..... | 9 |
| Figure 4: Key Stakeholders | 10 |
| Figure 5: Parking Garage Elevation..... | 16 |
| Figure 6: Parking Garage Cross Section | 18 |
| Figure 7: Typical T-Beam | 19 |
| Figure 8: Concrete Slab Cross Section | 20 |
| Figure 9: Parking Garage - Ground Floor | 22 |
| Figure 10: Parking Garage – Roof Level..... | 23 |
| Figure 11: Green Roof Assembly | 24 |

1.0 Project Overview

On September 8th, 2016, UBC formally requested that Team 19 investigate the feasibility of modifying the spiral drainage system at the north end of UBC's Point Grey campus. Currently, the spiral drain's capacity is to convey a 1:10 year storm event directly to the ocean through an outfall. The spiral drain was originally constructed in 1937 in response to a large-scale washout in 1935 [1]. In the 1994, significant erosion occurred, which led to the construction of a detention berm to increase the capacity to a 1:70 year storm event. These parameters do not meet UBC's stormwater objectives, which is the basis of this investigation.

The chosen design for this project consists of a new multilevel parking garage including an underground reservoir, with four drainage mains leading to a cylindrical receiving tank before the storm water is dropped 61m vertically and discharged into the ocean. To effectively utilize the limited flow capacity of the spiral drain a new design or practical solution is needed to accommodate up to a 1:200 year storm event or a volume of 9100m². Contributions from each group member to the following report can be seen in Appendix A.

1.1 Project Objectives

Team 19 was enlisted to design a modification to the existing stormwater drainage system to accommodate a 1:200 year storm event. This could take the form of either a total replacement of the aforementioned spiral drain, or a companion system that could be incorporated into the existing infrastructure. It is critical that the redesigned system protects of the sensitive cliff environment to the north of the existing spiral drain from erosion.

The environmental impacts, costs, and stakeholder disturbances resulting from the project must be mitigated or eliminated whenever possible, and the solution must be aesthetically pleasing

and appealing to the public.

A program of works must also be developed that projects completion of construction within a reasonable time frame. A corresponding maintenance plan must be produced to minimize future disruption and ease of replacement. In order to further future-proof the design, systems will also be investigated which minimize storm water flows from campus, such as building rain collection.

1.2 Site Description

The site, where the spiral drain currently resides, is located on the northern catchment area directly north of the Museum of Anthropology. Surrounding the area of the spiral drain, exist detention berms, MOA pond area, and vegetation.

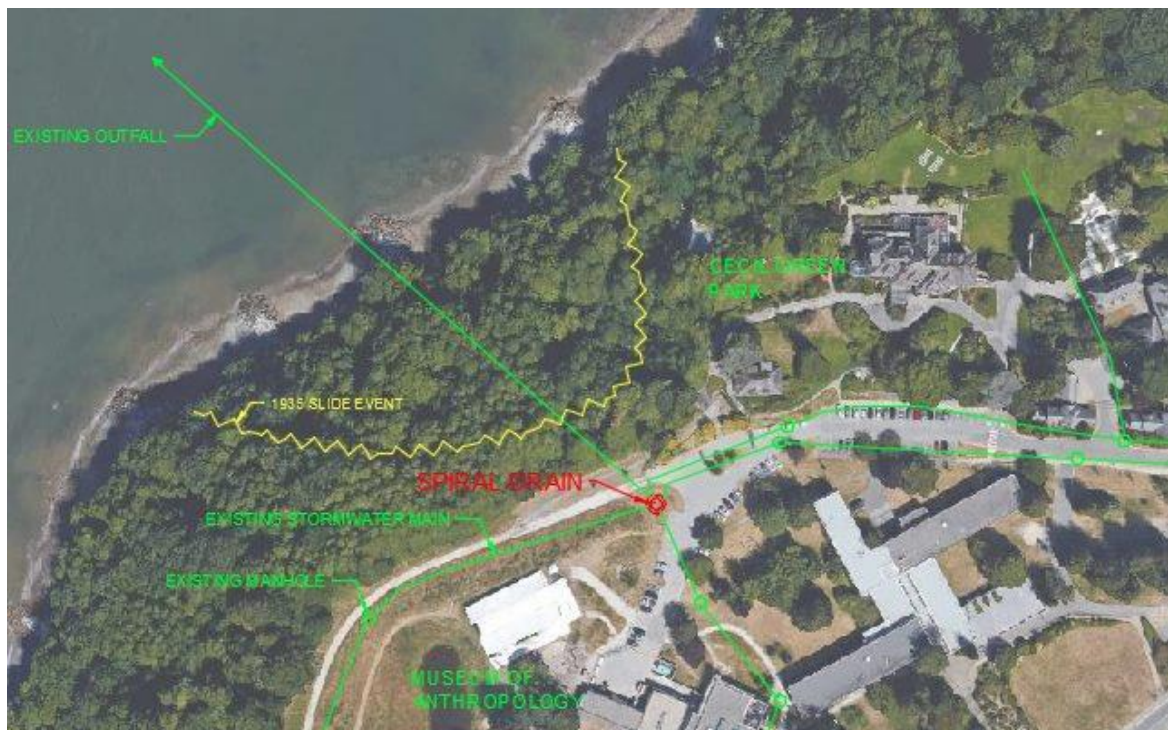

Figure 1: Spiral Drain Location

1.3 Building Information Modeling (BIM) of Proposed Structure

In order to visually represent our team's design of the proposed parking garage structure, a 3D model was constructed using Revit Architecture. The model images seen in Figures 2 and 3 below, display the structure of parking garage which will have a lower concrete reservoir and concrete substructure for the first level of parking. To collaborate with UBC SEEDS sustainability initiatives, the roof will be a green roof and the superstructure will be built out of timber glulam and cross-laminated timber which act as a carbon sink. Full elevations and further images of the structure can be seen in Appendix B.



Figure 2: Overall exterior 3D view of parking garage structure



Figure 3: Close-up exterior 3D view of parking garage structure

1.4 Site Requirements Regarding Existing Infrastructure

In order to accommodate the reservoirs for our storm detention structure some existing utilities were required to be removed and relocated. As shown in Appendix D, our team has drafted a preliminary layout identifying which utilities are affected along with proposed locations for the relocating of the affected services. The parking garage structure will require the removal of a portion of existing water main along with the required relocation of one existing fire hydrant. Our proposed design to meet the existing requirements includes 90m of 250mm PVC pipe and

the relocation of the fire hydrant to the ROW off of NW Marine Drive. As for the sewer utility conflict a portion of existing sewer line and one existing manhole along the south side of the parking structure will be removed. The new proposed design will require 130m of 300mm PVC pipe along with the construction of one sewer manhole built to MMCD standards in order to conform to the UBC Technical Guidelines. The conflicting electrical utilities from the proposed parking garage will require removal of line within the structure footprint along with 180m of 5” Duct in Concrete Conduit to provide the pre-existing requirements. In addition to the relocation of existing utilities the parking garage footprint is located over a portion of MOA parking lot and therefore asphalt removal and resurfacing will be required and its design will need approval by others.

1.5 Stakeholders

Team 19 has identified the key stakeholders listed in Figure 4 as being critical to the success of this project.

| Land Use Authorities | Environmental Management | Local Members of the Public |
|---|---|---|
| <ul style="list-style-type: none"> • Metro Vancouver Parks • Musqueam First Nations Band • UBC Endowment Lands • University of British Columbia | <ul style="list-style-type: none"> • Department of Fisheries and Oceans • Environmental Action Groups | <ul style="list-style-type: none"> • Museum of Anthropology • Cecil Green Park House • Residents in the vicinity |

Figure 4: Key Stakeholders

Stakeholder engagement can be broken down into two phases: *preconstruction* and *construction*. Throughout both periods, our goal is to reach out to stakeholders early and provide them with ample opportunities to provide feedback and input, as well as to keep them informed and updated during various phases of the project. Individual components of these phases are described in detail below.

Public Forums (Pre-Construction)

Monthly public forums will be held throughout the pre-construction phase to give stakeholders a chance to provide input on the project. Additionally, immediately following these forums, representatives from each of the stakeholder groups listed in Figure 4 will be invited to a meeting with Team 19 designers in which immediate feedback can be further discussed.

Project Website (Pre-Construction/Construction)

A project website will go online in the summer of 2017, and will be updated information on the design as it takes shape. In addition to design details, minutes will be summarized and posted following the monthly forums and the project program will be updated to allow the public to plan for upcoming construction stages. A feedback form will also be used to provide an avenue for the public to contact the design team directly with their questions and concerns.

Notices (Construction)

While best efforts will be made to minimize disruption, residents near construction works will be informed in advanced any changes to traffic and other unavoidable disturbances. This will be accomplished through the posting of signs, flyers and direct phone calls.

Telephone Hotline (Construction)

During the construction period, the contractor will be required to set up a publicly accessible telephone hotline. This will allow members of the public to contact the construction team directly in the event of an immediate disturbance or emergency.

2.0 Hydrotechnical

The current system consists of four drainage mains leading to a cylindrical receiving tank before the storm water is dropped 61m vertically and discharged into the ocean. To effectively utilize the limited flow capacity of the spiral drain, it was determined that a parking garage with underground water storage would be most adequate to accommodate up to a 1:200 year storm event or a volume of 9100m³. The reservoir will be located below the parking levels and will be capable of storing excess stormwater flow. The detailed design of our water detention structure was drafted in Civil 3D and adapted from our preliminary design drawings. Using Civil 3D, we were able to overlay the as constructed drawings of all the existing underground utilities provided to our design team. With the topographic data provided, we were able to construct a 3D surface of the majority of UBC's northern drainage catchment. With this surface and the locations of the existing underground utilities we were able to find the ideal location for our proposed structure and storm sewer alignment. For the proposed drainage mains, Civil 3D's pipe network tools were used in order to locate the most ideal locations topographically and with greatest ease of construction. In addition, detailed profiles of the plans were easily drafted after the infrastructure was modeled as a pipe network.

Hydrotechnical Design

Following the site investigation and analysis of the as-constructed utility and topographic maps provided to our team we were able to assess the feasibility of this solution. Due to the distance from the underground reservoir and the limited volume of water the north-west trunk main delivers the decision was made to not alter the route of said main. Our updated design diverts storm water from the remaining three trunk mains to a detention tank, then from this storage a new 750mm concrete main diverts water directly to the existing spiral drain. Water will be

discharged to the spiral drain at a controlled rate, below its limiting capacity as it is transported through the spiral drain and discharged to the ocean.

The two major trunk mains transporting water from the northwest portion of campus will be diverted down NW Marine Drive towards the MOA. The two existing 600mm mains will be combined into one 1100mm storm main and will be capable of delivering the equivalent capacity. The proposed storm infrastructure will in all sections exceed the minimum grade of 0.1% and will be constructed in the shoulder of the road in order to avoid a costly road excavation. The site of the parking garage was chosen due to its proximity to the spiral drain, the availability of land, and the proximity to the major trunk mains and underground utilities. The location conflicts with short spans of existing water and sewer main but to compensate our team proposes alternative routes where the existing infrastructure can be re-routed with limited excavation as discussed in Section 1.4. All newly installed AC concrete drainage pipes and PVC utilities will have an estimated service life of 50-100 years as per manufacturer's estimates. The plan view of the proposed water main re-alignment can be seen in Appendix D.

Reservoir Discharge to Spiral Drain

Using the flow out of a vessel calculation as described by Hayward [18], our team modeled the maximum possible flow rate our reservoir would provide to the spiral drain while at the peak design head. As modeled by Northwest Hydraulics the maximum flow rate the spiral drain can receive without backing up is $3.31 \text{ m}^3/\text{s}$ [5]. Our proposed design uses a 750mm AC pipe to discharge from the reservoir to the spiral drain and with minor and major losses the maximum flow rate it can produce out of the orifice is $2.51 \text{ m}^3/\text{s}$. Our team believes that this will ensure adequate protection from the spiral drain backing up, even during a 1:200 year storm event.

3.0 Structural

The next step in the design of our project was the structural design for the parking garage itself. To do this, first the loading scheme was determined using the codes. Concrete elements were chosen to be designed for the underground storeys (reservoir and basement levels) due to its material properties that can resist the exposure to soil and associated elements. For the superstructure level, timber was chosen to provide a pleasing aesthetic as well as structurally efficient system. The design of the elements was done using Excel spreadsheets with the code, followed by the creation of structural layout drawings using AutoCad, SketchUp and Bluebeam. The final portion of this section will discuss the green roof and its impact on the project.

The structural components of this parking garage have been designed to meet a 50 year life. Further maintenance and inspections should be done regularly to meet or exceed this.

3.1 Loading

To determine the structural demands on the parkade, dead loads, live loads of occupants and reservoir loading, and snow loads were considered. In the final design report submission, two of the load bearing walls in both a local North-South and West-East orientation will be used as shear walls to resist lateral loading.

The final factored loads for each floor were calculated following guidelines from the National Building Code of Canada (NBCC). Each floor loading was tabulated based on the self-weight, superimposed dead load and live load from the code. The loads were then factored based on all the cases, with the maximum factored load case governing in the design. Finally, the factored loads were summed up for the design of each element on the particular storey of the building.

These loads were used in the detailed design calculation for the elements and can be seen in the following table.

| <u>Factored Loading Breakdown for Structural Elements</u> | Dead (kPa) | Live (kPa) | Snow (kPa) |
|--|-------------------|-------------------|-------------------|
| Roof - CLT | 6.55 | 4.80 | 1.82 |
| Roof - Glulam Beams | 7.55 | 4.80 | 1.82 |
| CLT Wall/Columns | 7.85 | 4.80 | 1.82 |
| Ground - Conc Slab | 3.78 | 2.40 | |
| Ground - Conc Beams | 5.02 | 2.40 | |
| Ground - Conc Wall/Columns | 5.93 | 2.40 | |
| Basement - Conc Slab | 3.78 | 2.40 | |
| Basement - Conc Beams | 5.02 | 2.40 | |
| Basement - Conc Wall | 6.01 | 2.40 | |
| Reservoir - Conc Slab and Pedestals | 32.14 | 4.80 | |

Table 1: Factored Loading for Structural Elements

A critical point of live load came from the green roof, which was accessible to the public and therefore required a significant load. The dead load for the green roof was also significant due to the vegetation and soil depth. The most substantial dead load came from the reservoir water itself, which would be completely filled up in a 1:200 year flood level. The lateral wind and earthquake loads were also studied for design and check of the shear wall resistance.

A typical cross-section of the building, designed to accommodate these loads, is given in the following Figure 5.

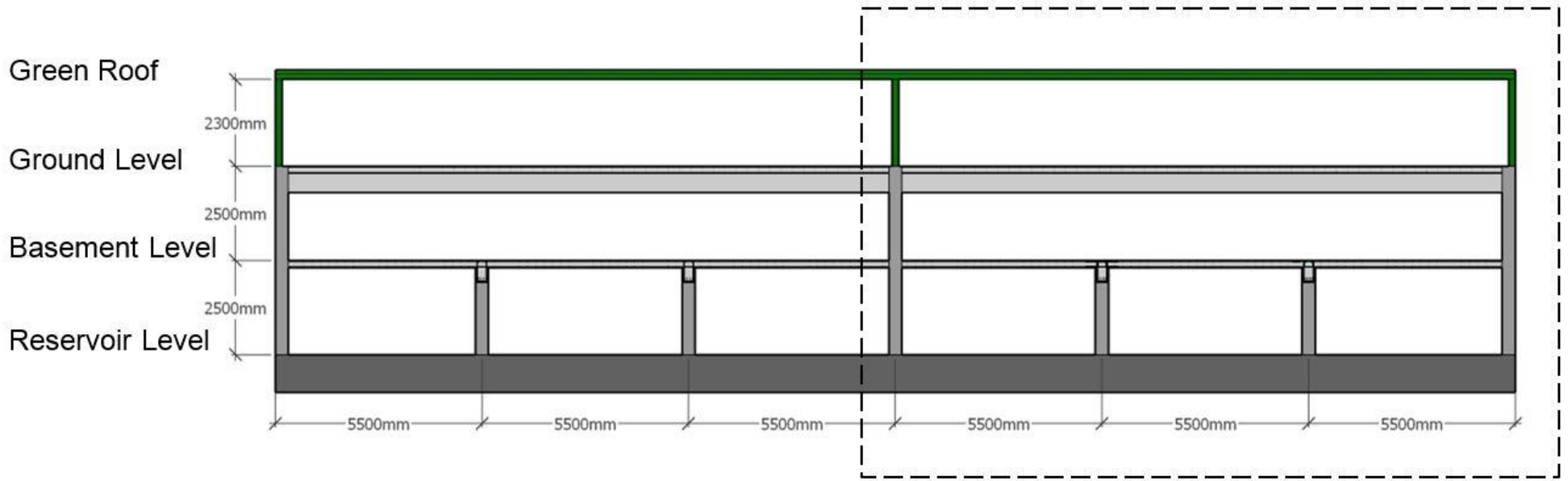

Figure 5: Parking Garage Elevation

3.2 Structural Design

The goal of the design was to maintain the aesthetics of the building's conceptual design, while still providing an economical and functional structure. Since the functions of each floor varied greatly, so too did the designs over the height of the structure. For example, the reservoir level is kept out of view from the public and thus conservation of open space was not as critical. In contrast, the parking levels and roof were designed with user experience and parkade functionality in mind.

3.2.1 Reservoir Level

Since the reservoir will now be a critical element of the UBC drainage network, it was of critical importance to the design team that the system still function in the case of a seismic event. In order to accomplish this, a great deal of redundancy was built into the reservoir level. An array of 36 concrete columns prevents catastrophic seismic failure by over-reinforcing the ground floor, and providing multiple vertical load paths in the event of an earthquake. These are highlighted in Figure 6 below.

Since the reservoir will only be visited for maintenance purposes, column spacing was optimized to minimize span lengths of the floor beams above. These columns will be spaced at 5.5m along the transverse axis of the building, and at 10m intervals longitudinally (out of the page in the drawing below). Columns are to be 350x350mm in size, with 4No. 35M bars with 10M ties spaced at 350mm.

The columns will be produced using a C20/25 concrete mix typical throughout the design of the building. However, a notable difference in the concrete composition of the reservoir columns is that they will feature an admixture of silica fume (ratio to be determined by independent laboratory testing). The columns will be exposed consistently to a damp environment, and the

stormwater funnelled to the reservoir is likely to have dissolved salts (chlorides). The goal of the silica fume will be to reduce the long-term permeation of this water and salt to the rebar within.

The columns will be connected by T-beams which serve as the primary support of the parking slab in the basement level. A typical T-beam cross section for this level is magnified in Figure 6.

These 300mmx600mm beams will utilize 8-25M flexural reinforcement bars and 10M stirrups.

To provide additional torsional stiffness of the beams, the stirrups will be closed.

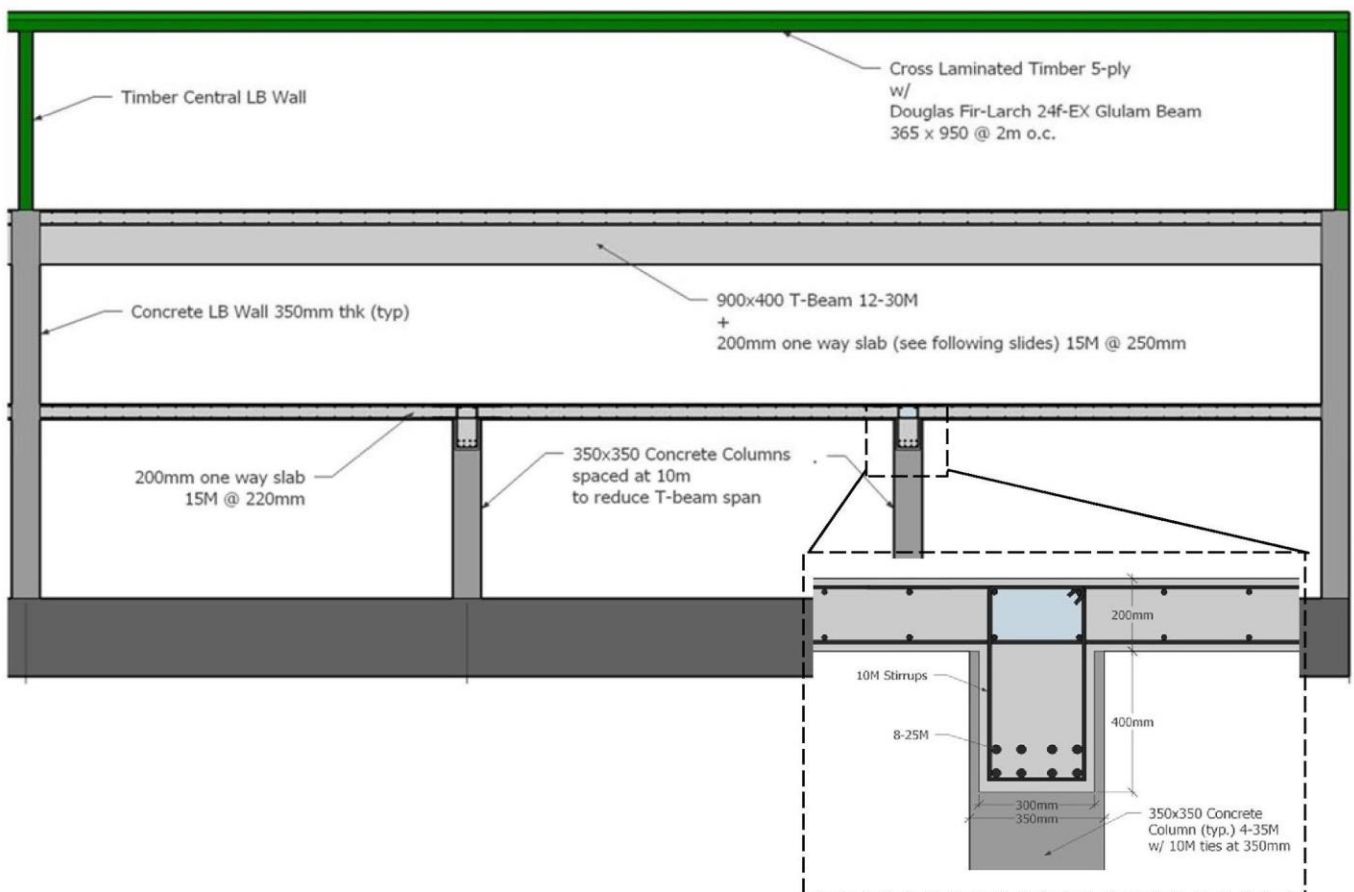

Figure 6: Parking Garage Cross Section

3.2.2 Basement Level

The design team recognized that underground levels of parkades can tend to feel enclosed and tend to leave the user with something of a claustrophobic feeling. To counteract this, the final design features long-span concrete T-beams spanning 16.5m from central to external walls. This will improve the overall aesthetic of the lower level and reduce the number of columnar supports required. The T-beams used will be 400x900mm in size, and utilize 12-30M reinforcement and 10M closed stirrups (for torsional stability). They will use the typical C20/25 mix used throughout the design in non-submerged locations. A typical beam can be seen in Figure 7 below.

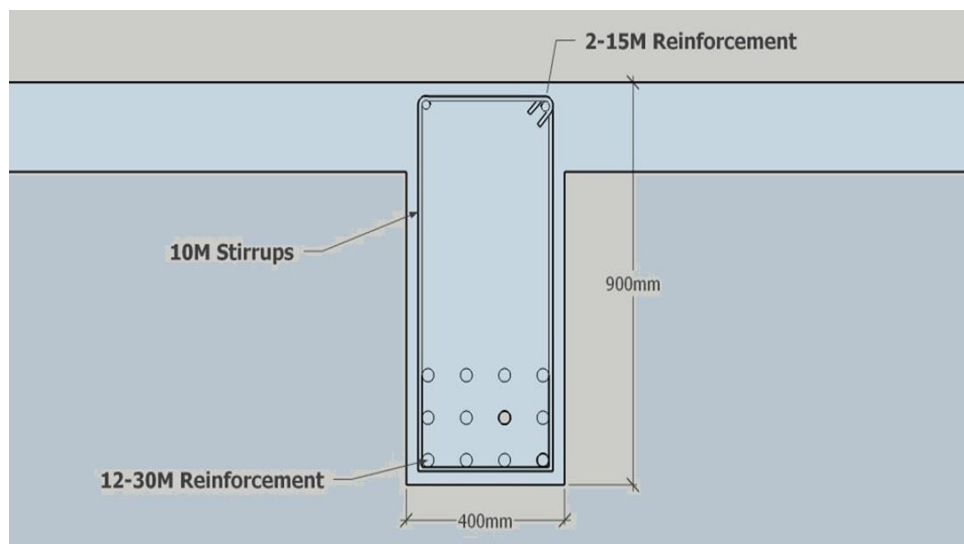

Figure 7: Typical T-Beam

Slabs in both the basement and ground levels follow the typical design of a one-way slab, with major flexural reinforcement spanning between T-beams. Flexural reinforcement will be 15M bars spaced at 250mm intervals along the slab, to accommodate both negative and positive bending. A typical cross-section of this span is given in Figure 8. Since the parkade is unheated and will be exposed to severe temperature fluctuations between seasons, 10M temperature

reinforcement was calculated to be placed at short 250mm spacing transverse to the flexural reinforcement for the slab.

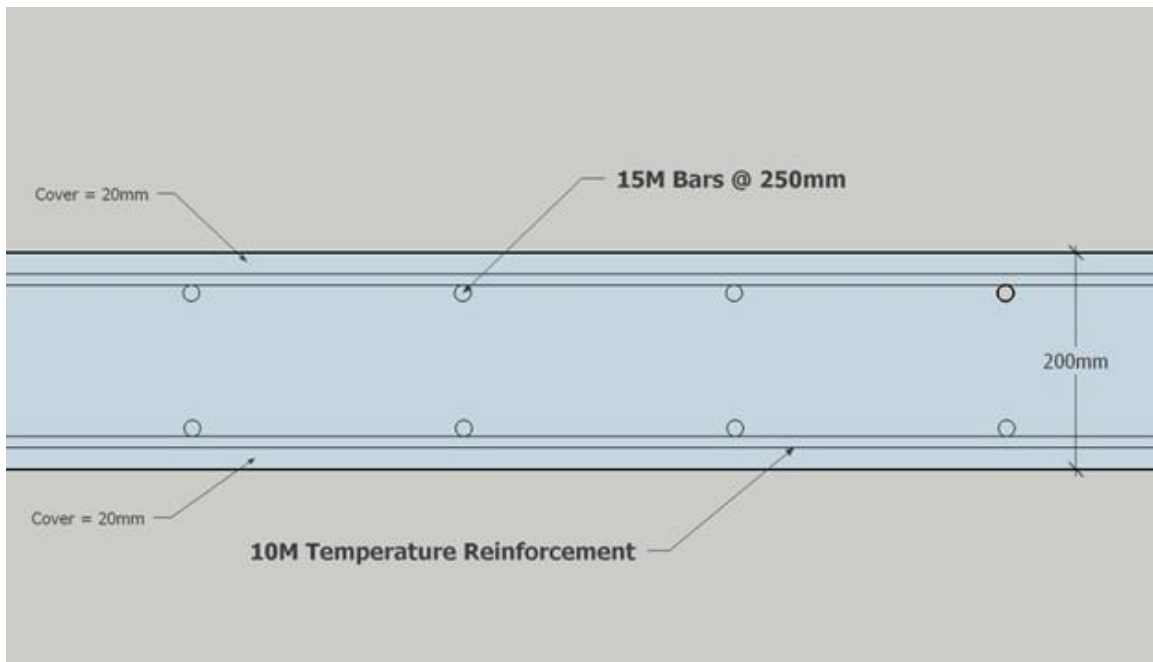

Figure 8: Concrete Slab Cross Section

3.2.3 Ground Level

Above-ground parkade levels have a reputation for brutalist architectural designs, composed primarily of concrete. Our design team set out to change that by producing an open, naturally lit timber-based level supporting a green roof. The ground level envelope of the parkade will be entirely composed of glulam beams and columns, with a CLT-supported roof and shear walls. Columns and beams were sized using the Timber Design Manual (2010). In order to accommodate the vertical load of the green roof, 265x265mm Glulam Columns (D Fir L. 16c-E) will be placed at 6m intervals around the perimeter of the level. Loads will be evenly distributed among the beams by 6m simply supported beams 365x760 (D Fir L. 20f-E). The design team chose to use simply supported beams for two reasons:

1. Fabrication and transportation is simpler for shorter beam lengths, minimizing construction costs.
2. Simply supported beams will not transfer rigid moments to the columns, which makes them less susceptible to failure during a seismic event.

In place of the 3 central-most columns at ground level at each side will be a 12m CLT shear wall. The wall will be 5-ply Structurlam CLT, 175V V2M1.1. The walls were sized to length so that the same design could be used as is present in the roof structure, facilitating construction and reducing costs through bulk purchasing of materials.

To support the green roof loads, 5-ply CLT panels were again used, spanning over 365 x 950 Glulam carrier beams at 2m on centre. These Glulam beams span to the edge beams discussed above.

Detailed Design calculations can be found in Appendix E.

The following plan layouts show the structural framing for both the ground level and roof level, to demonstrate how the load is distributed to the elements.

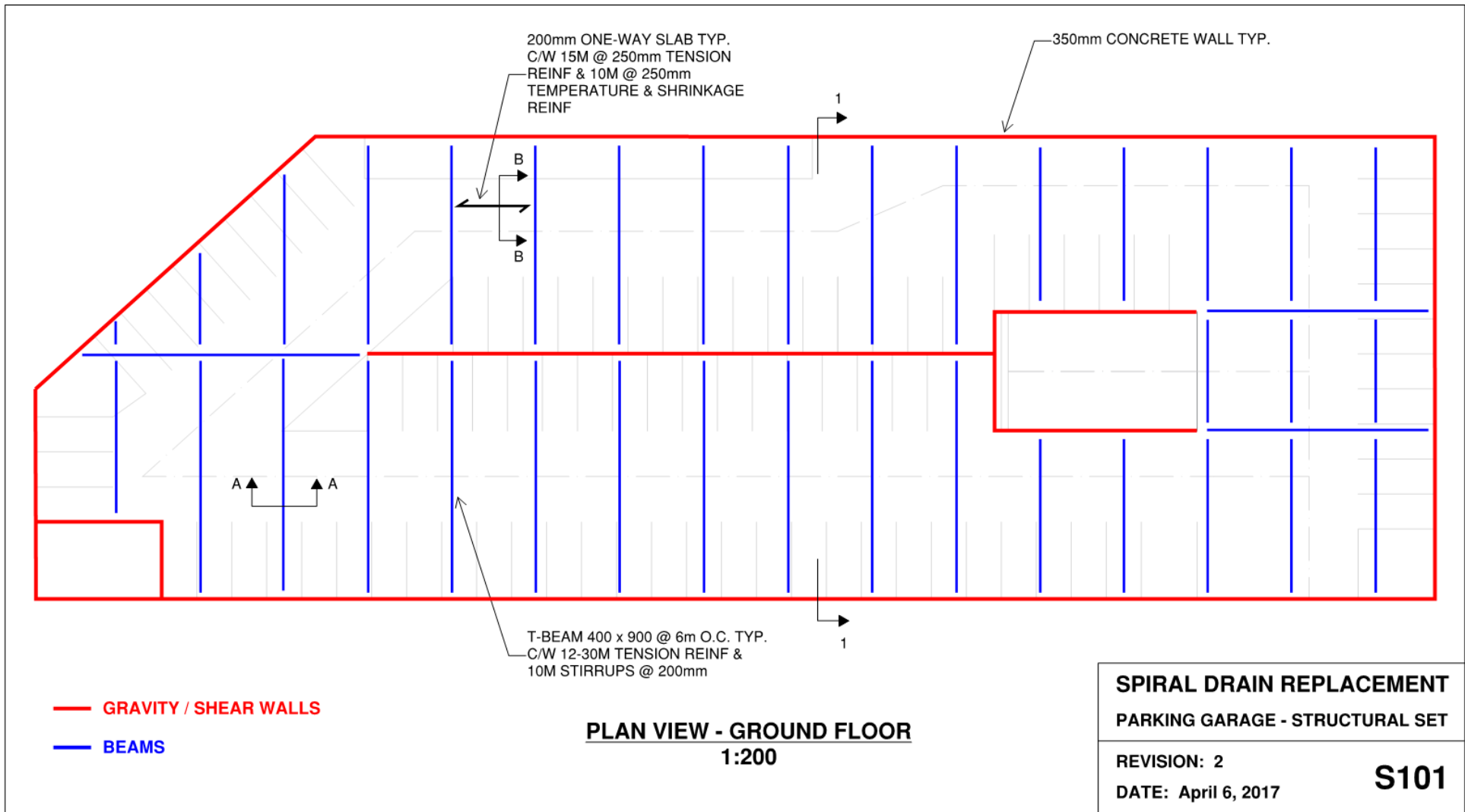

Figure 9: Parking Garage - Ground Floor

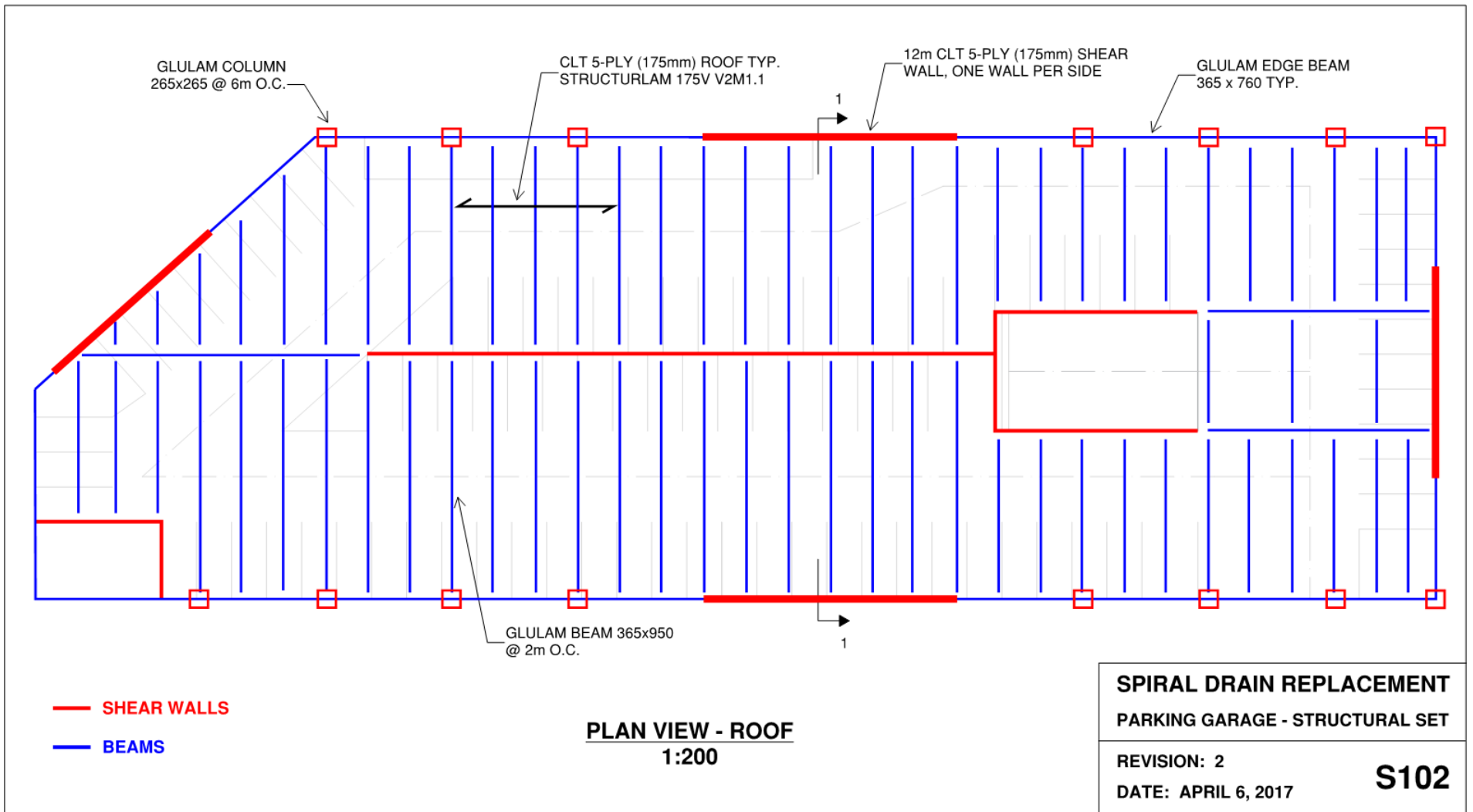

Figure 10: Parking Garage – Roof Level

3.3 Green Roof

Green roofs are an ecologically sensitive, energy-efficient upgrade of the traditional tar, gravel or plastic membranes typically used for roofing.

The green roof will provide multiple environmental benefits to the proposed parking garage and surrounding area including:

- Reducing stormwater runoff
- Reducing imposed stormwater fees
- Improving air quality by filtering pollutants and CO₂ from the surrounding air
- Promoting biodiversity by creating natural habitats
- Providing a rooftop terrace area for students to leisurely relax or study

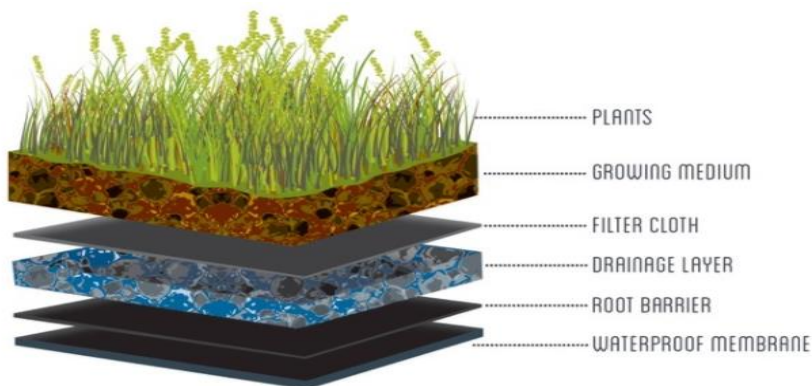

Figure 11: Green Roof Assembly

Traditionally, gravel roofs have a life expectancy of 15-25 years, yet green roofs can have a life expectancy of more than 40 years [19]. This is due to the fact that gravel roofs provide little to shield from environmental factors causing the roofing membrane to be exposed to all elements and age much faster. In comparison, the vegetation and substrate layers of a green roof provide full protection for the waterproofing membrane. In accordance with UBC SEEDS sustainability initiatives, native plant species such as: acer circinatum (vine maple) or polypodium glycyrrhiza (licorice fern), are recommended for use as additional vegetation.

4.0 Geotechnical

The structural loads through the building were immense due to the large volume of water required in the reservoir. Shallow spread footings were initially attempted, but due to the high loads it became uneconomical and physically unfeasible with the site. Driven prefabricated piles were selected for their longevity and high axial capacity. 400mm x 400mm reinforced concrete piles are proposed with 21m lengths. 144 piles are required for the foundation. 127 piles will be placed at a 2m spacing along the perimeter wall of the structure. 17 piles will be placed along the centre shear wall at a spacing of 1m.

Driven to a depth of 21m, the piles are located within a Quadra Sand unit (Piteau, 2002). This sand is noted to be a compact to dense fine to medium sand. From the Piteau (2002) report the water table was noted at an elevation of 46m to 48m a.s.l., therefore, groundwater was ignored during calculations. Group effects of piles were ignored, where an efficiency of one would have been utilized, due to minimal interference between piles. Settlements, according to Meyerhof's, will be under 5mm according to:

$$\rho = d_b / 30 F$$

Standard penetration tests (SPT) will need to be conducted to determine the soil parameters with greater precision, as part of NBCC requirements.

Design Inputs

Once the project is deemed feasible site investigation of the soils will be required to confirm the assumed soil parameters. This is also a requirement to meet the basic NBCC necessities. Soil strength parameters were conservatively assumed from Piteau's (2002) report, which resulted in the following assumptions for a medium dense sand:

- Unit weight of 19 kN/m³

- Soil friction angle of 33 degrees
- A modulus of elasticity of 12,000 kPa
- N_q of 20
- β or 0.8

From the factored loads from the structure were then reduced by a NBCC Resistance Factor of 0.4 for semi-empirical analysis. See Appendix F for pile capacity calculations.

5.0 General Project Requirements

5.1 Project Milestone Schedule

One of the major requirements to be considered in the implementation of this project is how long the construction itself would take. This is important due to the negative public impacts possible during construction such as roadblocks and rerouting, walkway diversions, event disturbance and parking obstructions. Since the parking garage design solution requires a great variety of site work, well-thought planning and design is important to generate a fast, efficient on-site schedule.

Refer to Appendix G for a full project schedule.

5.2 Project Costs

This section presents the updated Class C cost estimate for the Parking Garage with Underground Reservoir project at UBC, Vancouver, British Columbia. First, the detailed cost estimate breakdown will be presented, with associated categories of project costs. The scope of the estimate will then be discussed, in terms of inclusions and exclusions. Finally, a life-cycle cost analysis will be presented to give a sense of the payback period associated with the project. It is to be noted that a Class C cost estimate is based off information and schematics that are not yet approved or finalized. Therefore it is to be used for reference only and can be considered to be to +/- 20-30% accuracy.

5.2.1 Cost Estimate Summary

This estimate is including applicable local BC taxes and is in Canadian dollars. Construction costs for general conditions, excavation, geotechnical work, parking garage structure, drainage system and civil work were all itemized and totalled approximately \$8.3 million. Due to the nature of

the estimate, a contingency of 10% was added to the construction costs to bring them to about \$9.2 million. Next, consultant costs for architecture, engineering, hydrotechnical and landscape components were estimated as almost \$1 million. With these components, the overall base project cost is estimated to be \$10.1 million. With a total floor area of approximately 9360 m2, the project cost comes to about \$1082/m2 or \$100/ft2. This is reasonable considering other similar construction projects, and the extent of hydrotechnical scope involved.

The detailed cost estimate can be found in Appendix H. The following table summarizes the overall cost categories:

| | |
|--|--------------|
| <u>Construction Costs:</u> | |
| 1. General Construction Costs | \$1,211,200 |
| 2. Excavation | \$2,006,757 |
| 3. Parking Garage | \$3,838,759 |
| 4. Drainage System | \$814,650 |
| 5. Road and Civil Works | \$461,869 |
| 6. Construction Contingency @ 10% | \$833,324 |
| | \$9,166,560 |
| <u>Consultant Costs:</u> | \$957,905 |
| <u>Total Base Project Cost:</u> | \$10,124,465 |

Table 2: Project Cost Breakdown

5.2.2 Scope of Estimate

The following inclusions and exclusions demonstrate the primary scope items for this project.

Inclusions:

- Design, consultant fees
- General conditions:
 - Permitting
 - Site supervision
 - Project management
- Bonding
- Insurance
- Taxes (GST and PST)
- Site General Costs:
 - Site offices, temporary power and water
 - Site security and first aid
 - Crane rental and operation
 - Equipment and tools
 - Mobilization and Demobilization
 - Other miscellaneous site services and supplies
- Construction costs:
 - Excavation
 - Concrete underground reservoir
 - Concrete basement level
 - CLT and Glulam above ground level
 - MEP costs
 - Finishes
- Drainage system
 - Reroute existing pipes to underground reservoir
 - New pipes from reservoir to spiral drain
 - Reservoir sensors, equipment
- Roads and Civil Works
 - Entry road
 - Green Roof
 - Landscaping
- Project risk and contingency costs

Exclusions:

- Property costs
- City administration costs
- Financing costs
- Costs associated with rerouting traffic during construction
- Legal fees
- Costs associated with design or program change
- Operating, maintenance costs (discussed next section)

5.2.3 Lifecycle Cost Analysis

An important part of the cost analysis for this project is the long-term operations and maintenance (O&M) costs compared with earned parking revenues. An analysis was carried out for this parking garage and represents a potential payback scenario. The table below summarizes these annual costs and revenues:

| Overview of Yearly Cash Flow | |
|--|----------------------|
| Fixed Project Costs: | -\$10,124,465 |
| Annual Operating & Maintenance Costs: | |
| Security and access control | -\$15,000 |
| Fee collection | -\$5,000 |
| Cleaning / Upkeep | -\$20,000 |
| Inspections / Monitoring | -\$15,000 |
| Landscaping / Snow removal | -\$5,000 |
| Repairs / Resurfacing (average) | -\$25,000 |
| Insurance | -\$10,000 |
| Total | -\$95,000 |
| Annual Parking Revenue: | |
| # parking stalls | 165 |
| Average revenue per stall per day | \$13 |
| Total revenue per year | \$782,925 |
| Total Yearly Cash Flow | \$687,925 |

Table 3: Overview of Annual O&M Costs and Parking Revenues

Using this yearly cash flow, a lifecycle analysis was performed to determine the break-even period. As can be seen in the table below, due to earned parking revenues, the parking garage design and construction costs will be paid off in about 15 years. Since this is an estimate, the payback period could vary depending on actual revenues and maintenance cost by +/- 3 to 5 years.

| Payback Period: | Year 1 | Year 2 | | Year 14 | Year 15 |
|------------------------|---------------|---------------|------|----------------|----------------|
| Maintencance Costs | -\$95,000 | -\$95,000 | | -\$95,000 | -\$95,000 |
| Parking Revenue | \$782,925 | \$782,925 | | \$782,925 | \$782,925 |
| Total Lifecycle Costs | -\$9,436,540 | -\$8,748,615 | | -\$493,515 | \$194,410 |

Table 4: Project Payback Period

5.3 Environmental Impact

UBC has outlined its commitment to sustainability, and its desire for the campus to be viewed as a laboratory for sustainable design. This proposed parking garage and stormwater reservoirs has many aspects that are in-line with these sustainability objectives.

Utilizing a timber superstructure will be both environmentally friendly and aesthetically pleasing. Countless sources speak to the positive attributes of timber construction, in terms of carbon sequestration and storage. Above the timber superstructure will be a green roof that will aid stormwater retention for the garage’s footprint. Having an aesthetically pleasing roof and superstructure will be important due to the high volume of visitors to this portion of campus. This structure will be viewable from higher locations and by MOA and CGP visitors.

It has been identified that the spiral drain has approximately 50 years of remaining life in it if the status quo were maintained. Taking advantage of this time period will reduce the need for a brand new piece of infrastructure. As part of this proposal a rehabilitation plan will be provided for the spiral drain for when the need of an upgrade has arrived.

5.4 Maintenance

A limited amount of maintenance and inspection will be required through the project's lifespan, and will be more indicative of a typical garage due to its passive design. The Spiral Drain can be rehabilitated using CIPP (Cured In Place Pipe) polyurethane resin, further discussed in Section 4.9, which can increase the service life of the existing spiral drain by 50 years.

5.5 Rehabilitation of Spiral Drain

The reservoir beneath our proposed parking garage relies on the continued operation of the spiral drain in order to discharge-contained storm water volumes after large storm events. As a result the spiral drain must remain in working order longer than its present estimated service life of only 50 years. Our team recommends a complete rehabilitation of the existing spiral drain using a Cured in Place Pipe (CIPP) application method. CIPP is a trenchless form of pipe rehabilitation that has been used in practice for over 35 years and provides an extended service life of 50 years to the existing pipe [13]. This new layer will provide protection against erosion and ensure the structural integrity of the shaft while conforming to all ASTM standards. CIPP is applied with an inflatable liner impregnated with a polyurethane resin. The liner is inflated inside the pipe using water or steam to ensure complete contact of the existing pipe inner surface before the liner hardens and becomes the new rehabilitated pipe [15].

CIPP can be applied to pipe diameters up to 96" and has been utilized in lengths exceeding 500 meters [13]. In practice larger diameter rehabilitation practices use steam in order to minimize water consumption and reduce weight. For the spiral drain rehabilitation we recommend steam to inflate the liner and would require a liner thickness of 36mm to ensure the necessary strength of the 48" diameter outfall [14]. This rehabilitation method can be implemented on any pipe material, in any condition, and for any shape [13]. In order for the parking garage reservoir and

the spiral drain to provide long term flood protection we propose that the spiral drain be rehabilitated with the CIPP method within the next 30-50 years. It is imperative that the drain is rehabilitated before collapse or complete failure, but it is important to utilize as much remaining service life of the spiral drain as possible in an effort to be cost effective.

5.6 Future Policy and Development

“The University believes in sustainability because it is necessary as the ecological and human consequences of unsustainability are devastating; it is the right thing to do ethically and in terms of distributive justice; and, it is desirable in itself, offering the possibility of a better life for people and the planet.” [16]

In order to enhance campus sustainability, and align with many features of UBC SEEDS 20-year sustainability initiatives, the option of a water neutral concept can be added to our design proposal. This concept would incorporate future buildings surrounding the current spiral drain location to be designed to collect excess rainwater and harvest that rainwater for reuse within the buildings plumbing facilities. Reusing surrounding rainwater would reduce the amount of stormwater runoff in the existing drainage system, thus reducing the burden on the spiral drain.

In relation to our parking garage design, there is the option to add a community garden on top of the garage superstructure growing on the initial idea of a green roof. The community garden would promote sustainable food systems and could be utilized by surrounding student residences or incorporated into educational purposes such as for use in UBC's Faculty of Land and Food Systems.

6.0 Conclusion

In order to accommodate the required capacities of stormwater flow, Team 19 feels that our proposal for a reservoir parking garage is the best solution. The projects practicality, revenue generation and sustainable design ensure that it will provide social, environmental and economic benefits to the University for years to come. The comprehensive hydrotechnical, geotechnical, and structural analysis completed by our team gives us confidence in the effectiveness of our stormwater management system.

On behalf of Team 19, we would like to thank you for your time and consideration of this proposal. We are confident that your expertise will lead you to appreciate the projects merits. We look forward to working with all contributors and stakeholders, as well as, collecting valued input as we move into the next phase of this project.

References

- [1] Dr. M. Y. Williams. (1966). *UBC Alumni Chronicle* (Vol. 20) [Online]. Available: http://www.library.ubc.ca/archives/pdfs/chronicle/AL_CHRON_1966_4.pdf. [Accessed: 25-Nov-2016].
- [2] "Hydrological and Geotechnical Assessment of Northwest Area," Piteau Associates, North Vancouver, BC, Tech. Rep. 2154, Sept. 2002.
- [3] C. W. Hair III, "Site Investigation Requirements for Large Diameter HDD Projects," Louis J. Capozzoli & Associates, Baton Rouge, La., Dec. 1994.
- [4] GeoAdvice Engineering Inc., "UBC STORMWATER MODEL SYSTEM ANALYSIS, DETENTION ANALYSIS AND SYSTEM OPTIMIZATION", 2013. [Online]. Available: https://connect.ubc.ca/bbcswebdav/pid-3796195-dt-content-rid-18389089_1/courses/SIS.UBC.CIVL.445.101.2016W1.69280/TM%233-UBC%20Stormwater%20Model%20System%20Analysis%2C%20Detention%20Analysis%20and%20System%20Optimization-Final-June%2011%202013.pdf. [Accessed: 17- Nov- 2016].
- [5] Northwest Hydraulic Consultants, "U.E.L Drainage and Shaft Tunnel Hydraulic Model Study", 1999. [Online]. Available: https://connect.ubc.ca/bbcswebdav/pid-3796195-dt-content-rid-18389089_1/courses/SIS.UBC.CIVL.445.101.2016W1.69280/TM%233-UBC%20Stormwater%20Model%20System%20Analysis%2C%20Detention%20Analysis%20and%20System%20Optimization-Final-June%2011%202013.pdf. [Accessed: 17- Nov- 2016].

[6] Advicas Group Consultants Inc., "Class 'C' Estimate", 2010. [Online]. Available: <http://www.johnsonstreetbridge.com/wp-content/uploads/2010/06/A5.-Advicas-Cost-Estimate1.pdf>. [Accessed: 23- Nov- 2016].

[7] NTCRA, "Appendix J - Cost Details", 2010. [Online]. Available: https://www3.epa.gov/region10/pdf/sites/ldw/T117/appendix_j_cost.pdf. [Accessed: 24- Nov- 2016].

[8] D. Orth and C. Mains, "A Need for Expansion: Mechanical and Electrical Courses", 2009. [Online]. Available: <http://ascpro0.ascweb.org/archives/cd/2009/paper/CEGT189002009.pdf>. [Accessed: 24- Nov- 2016].

[9] APEGBC, "Budget Guidelines for Consulting Engineering Services", 2009. [Online]. Available: <https://www.apeg.bc.ca/getmedia/c31c2f50-83fe-4cc2-83a6-f3d9f81c6905/APEGBC-Budget-Guidelines-for-Consulting-Engineering-Services.pdf.aspx>. [Accessed: 22- Nov- 2016].

[10] PPP Canada, "Schematic Design Estimate Guide". [Online]. Available: http://www.p3canada.ca/~media/english/resources-library/ppp_dseg_eng_pf7.pdf. [Accessed: 24- Nov- 2016].

[11] Victoria Transport Policy Institute, "Transportation Cost and Benefit Analysis II – Parking Costs", 2016. [Online]. Available: <http://www.vtpi.org/tca/tca0504.pdf>. [Accessed: 26- Nov- 2016].

[12] Insureon, "How Much Does General Liability Insurance Cost?", 2016. [Online]. Available: <http://www.insureon.com/insureonu/costs/general-liability>. [Accessed: 27- Nov- 2016].

[13] Pipe Vision Projects, "What is Cured in Place Pipe Lining?", 2016. [Online]. Available: http://pipevisioninc.com/what_is_cipp.html. [Accessed: 22- Nov- 2016].

[14] AEGION, "CIPP Wall Thickness Calculator", 2016. [Online]. Available: <http://www.insituform.com/AboutUs/Design-Guide>. [Accessed: 22- Nov- 2016].

[15] CWW Canada, "CIPP: Cured in Place Pipe Lining", 2016. [Online]. Available: <http://cwwcanada.com/service/cipp-lining/>. [Accessed: 24- Nov- 2016].

[16] UBC, "20-Year Sustainability Strategy", 2014. [Online]. Available: https://sustain.ubc.ca/sites/sustain.ubc.ca/files/uploads/CampusSustainability/CS_PDFs/PlansReports/Plans/20-Year-Sustainability-Strategy-UBC.pdf. [Accessed: 17- Nov- 2016].

[17] <http://www.restorationgardens.ca/green-roof-layers-and-systems/>

[18] <https://www.haywardflowcontrol.com/images/flowcontrol/PDF/VessFlow.pdf>

[19] http://www.zinco-greenroof.co.uk/faq/life_expectancy.php

Appendices

Appendix A: Group Project Distribution

| Name | Responsibilities |
|---------------------|--|
| Delton Breckenridge | 1.0 Project Overview, 2.0 Hydrotechnical, 5.5 Rehabilitation of Spiral Drain |
| Gerald Epp | 3.0 Structural, 5.3 Cost Estimate, Report Compilation |
| Keith Russell | 1.0 Project Overview, 3.0 Structural |
| Michael Veerman | 1.0 Project Overview, 5.1 Project Schedule |
| Lindsey Waugh | 3D BIM Model, 1.0 Project Overview, 3.3 Green Roof |
| Chris Wickman | Executive Summary, 4.0 Geotechnical |

Appendix B: BIM Model Views









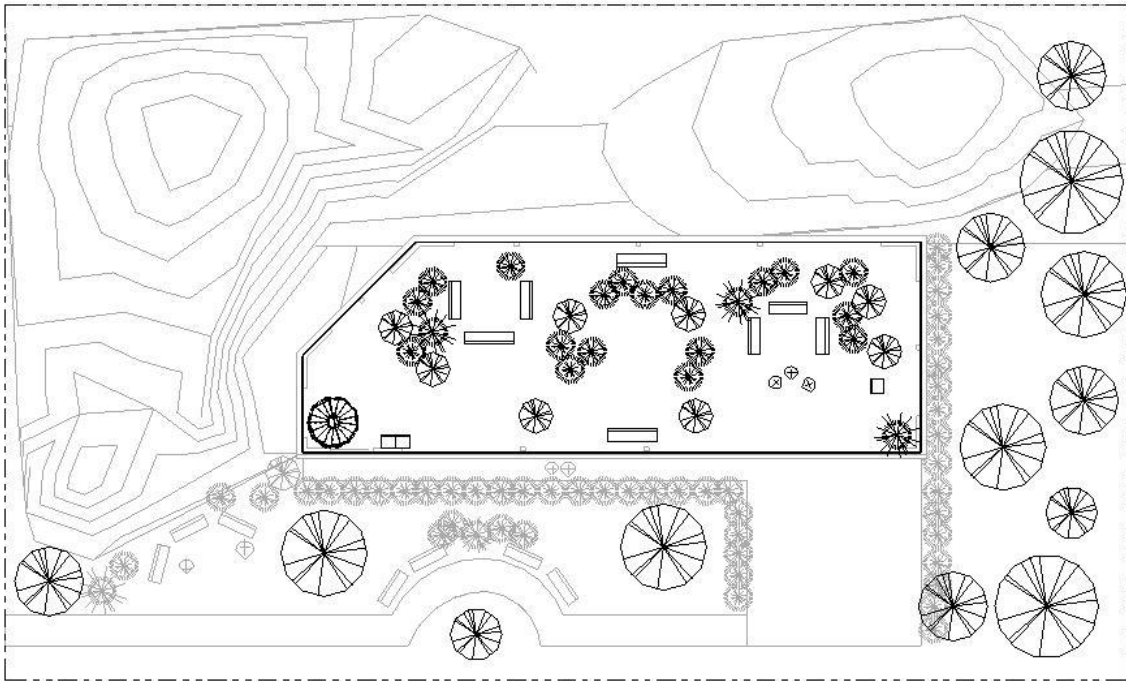
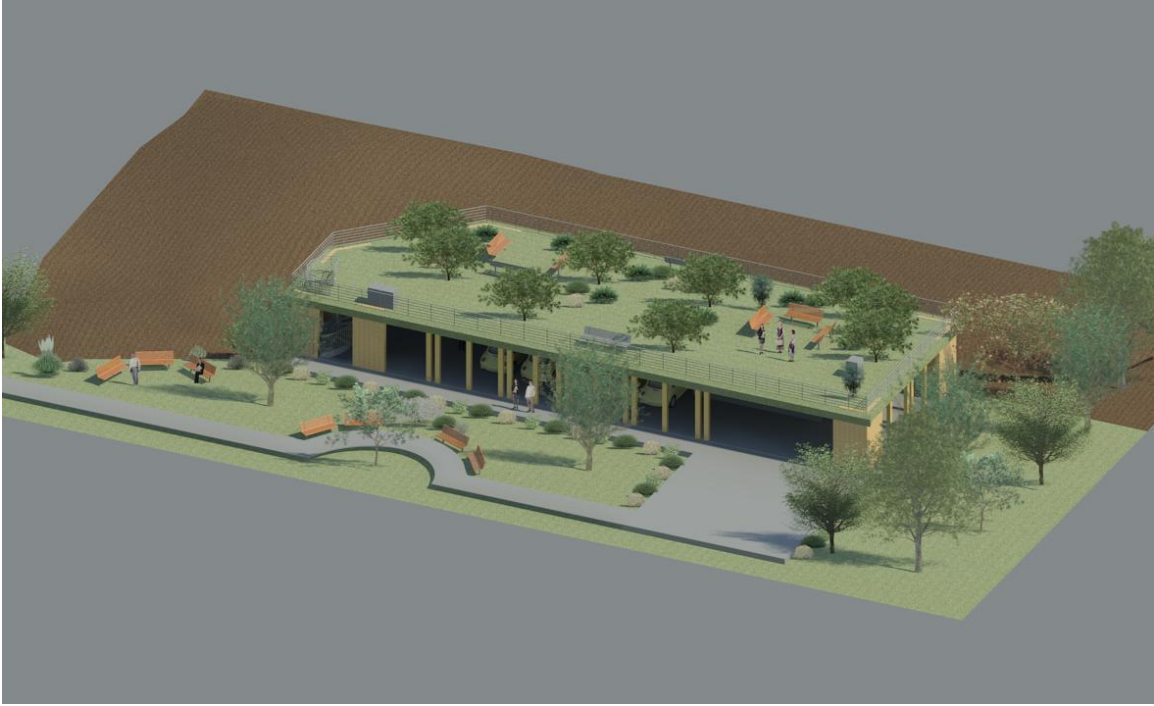

Appendix C: Services Plan View (following page)

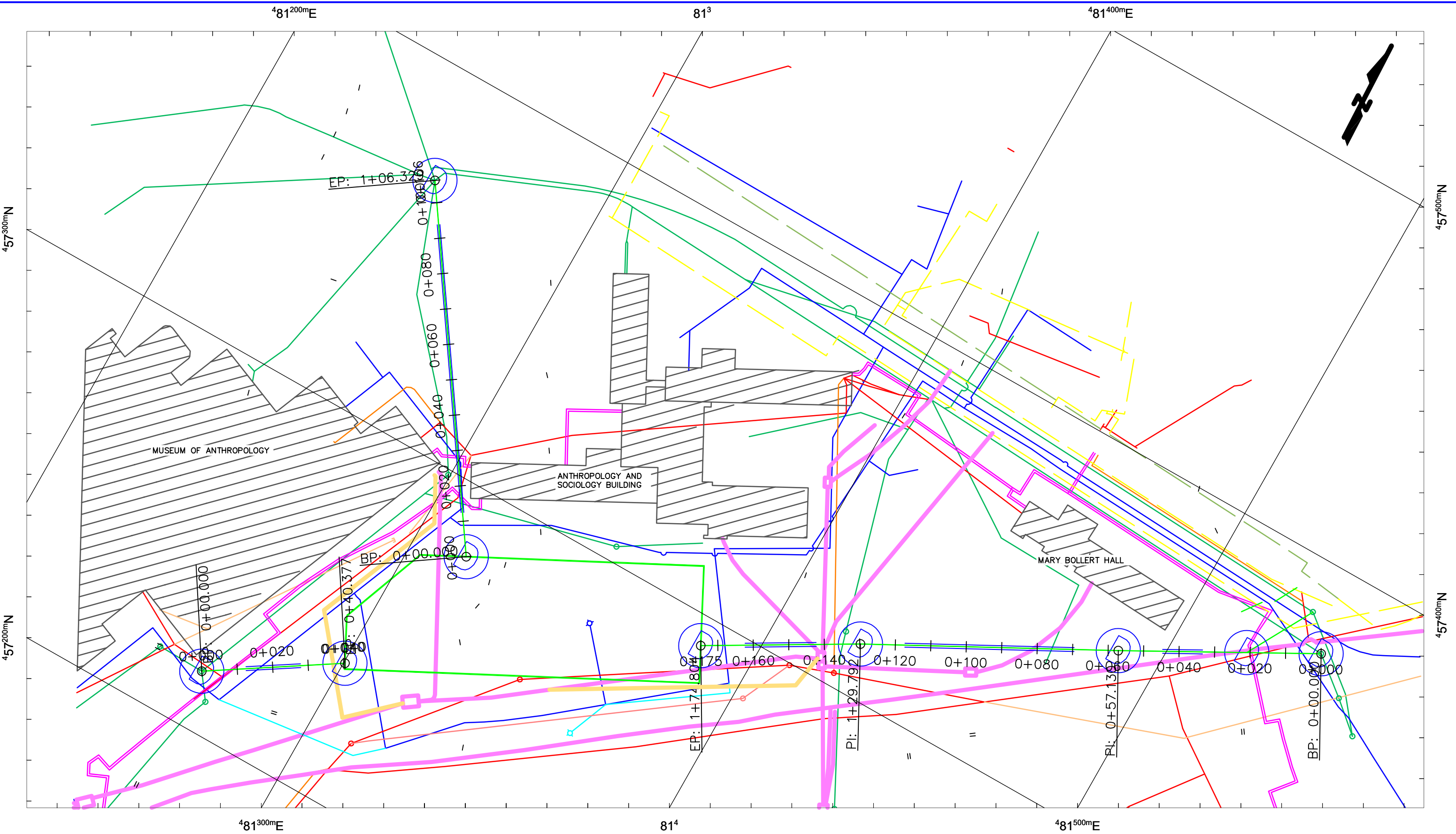

LEGEND

- EXISTING ELECTRICAL LINE
- EXISTING WATER LINE
- EXISTING SEWER LINE
- PROPOSED ELECTRICAL LINE
- PROPOSED WATER LINE
- PROPOSED SEWER LINE
- PROPOSED DRAINAGE LINE

CIVL 446
UBC
 Civil Engineering Capstone
 Spiral Drain Team 19

SERVICES-PLAN-VIEW

| | |
|------------------|-------------------------|
| NAME: TEAM19 | DATE: 06-04-2017 |
| SCALE: 1:1000 | DWG. NO. DRAWING-1/2 |

Appendix D: Topographic Plan (following page)

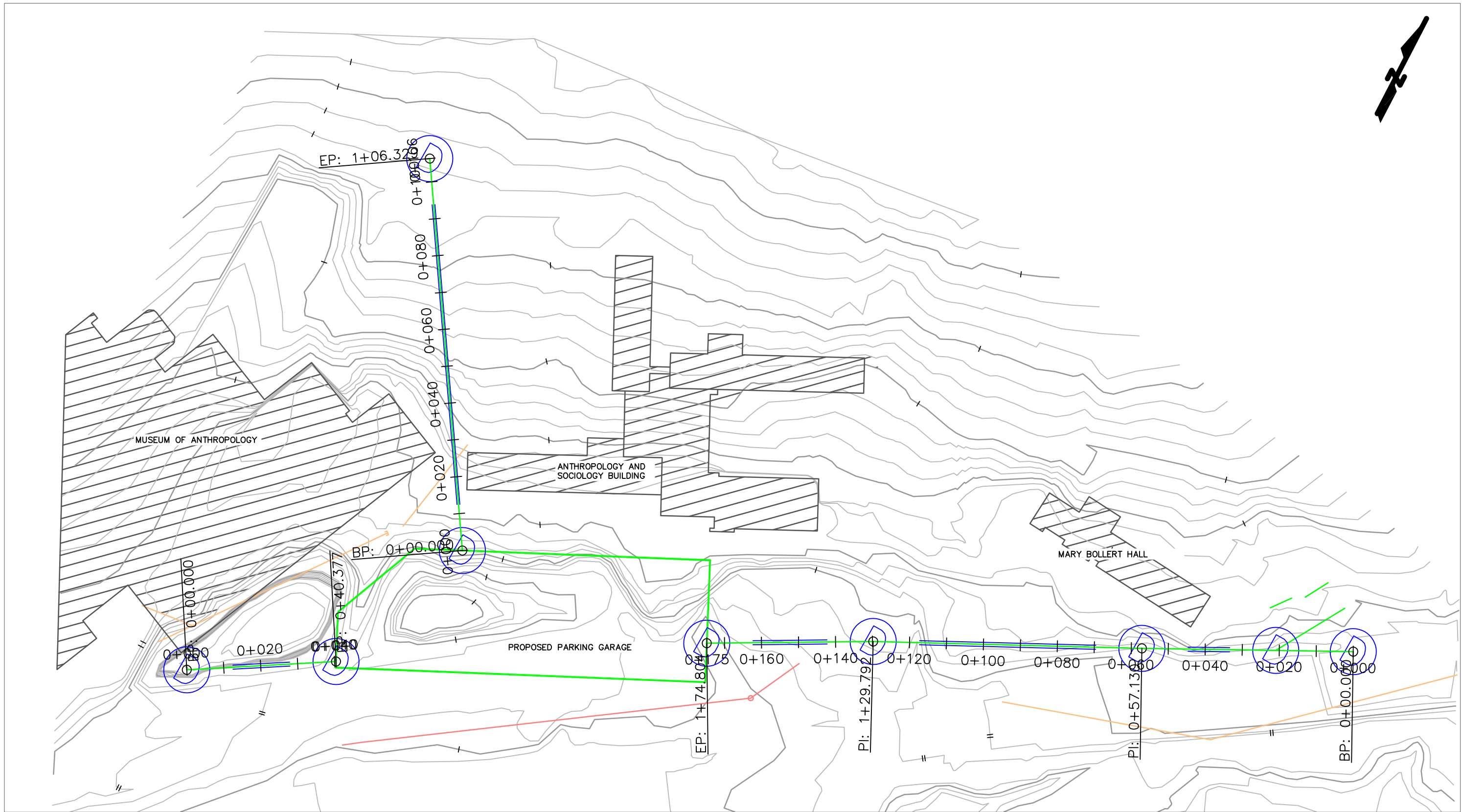

| LEGEND | | | |
|--------------------------|---------------------|---------------------|------------------------|
| EXISTING ELECTRICAL LINE | EXISTING WATER LINE | EXISTING SEWER LINE | PROPOSED DRAINAGE LINE |
| PROPOSED ELECTRICAL LINE | PROPOSED WATER LINE | PROPOSED SEWER LINE | |

CIVL 446
 UBC
 Civil Engineering Capstone
 Spiral Drain Team 19

TOPOGRAPHIC-PLAN-VIEW

| | |
|------------------|-------------------------|
| NAME: TEAM19 | DATE: 06-04-2017 |
| SCALE: 1:1000 | DWG. NO. DRAWING-2/2 |

Appendix E: Structural Calculations (following pages)

Column - Basement Level

Design Summary: 350x350 column, spaced at 10m along T-beams, 4No. corner 35M bars, 10M ties spaced at 350mm

Dimensions

| | | |
|-----------------------------|-------------------------|---|
| Tributary Area | 55.00 m ² | 9No. Columns spaced at 10m at reservoir level |
| side length | 350 mm | start with trial |
| Ag | 122,500 mm ² | |
| Floor Height | 2,500 mm | start with trial |
| Longitudinal Column Spacing | 10,000 mm | |
| Beam spacing | 5,500 mm | |

Loading

| | | |
|------------------------------|------------|--|
| Factored Axial Load | 542.85 kN | 2xMax Shear at T-beams |
| Unfactored Live Load | 3.60 kPa | from NBCC loading spreadsheet |
| wf,LL | 19.80 kN/m | |
| Max bending moment due to LL | 247.50 kNm | |
| Mf | 123.75 kNm | Half of max bending moment in one adjacent T-beam given factored live load |

Material Properties

| | |
|----------------|-------------|
| f _c | 25 MPa |
| f _y | 400 MPa |
| phi,c | 0.65 |
| phi,s | 0.85 |
| alpha1 | 0.813 |
| E _c | 22,500 MPa |
| E _s | 200,000 MPa |

Slenderness Checks

| | | |
|----|-------------|---|
| K | 1 | Assume K=1 (pinned, conservative) |
| Lu | 2,500.00 mm | |
| M1 | 123.75 kNm | Assume no seismic loading. Columns are below grade, assume base is at ground level. |
| M2 | 123.75 kNm | |
| r | 101.04 mm | |

| | |
|-----------------------|-------|
| KLu/r | 24.74 |
| Slenderness Parameter | 35.63 |
| Is column slender? | No |

| | | |
|------------------------|--------------------------|----------------|
| Cover | 40.00 mm | Assume FN type |
| Tie diameter | 10.00 mm | |
| Bar Diameter | 35.00 mm | |
| Ab | 1,000.00 mm ² | |
| Assumed number of bars | 4.00 No. | |
| d | 282.50 mm | |
| beta | 0.90 | |
| gamma | 0.6 | |
| Pr/Ag | 4.43 MPa | |
| Mr/(Agh) | 2.89 MPa | |
| rho | 0.0202 | |

Checking interaction diagram to right, acceptable for rho=.02

| | |
|-----------------------|----------------------|
| Checks | |
| Min Bar clear spacing | 49.00 mm |
| Max Bar Clear Spacing | 500.00 mm |
| Max Tie Spacing | 350.00 mm |
| Min Tie Diameter | 10.50 mm |
| | (approximately 10mm) |

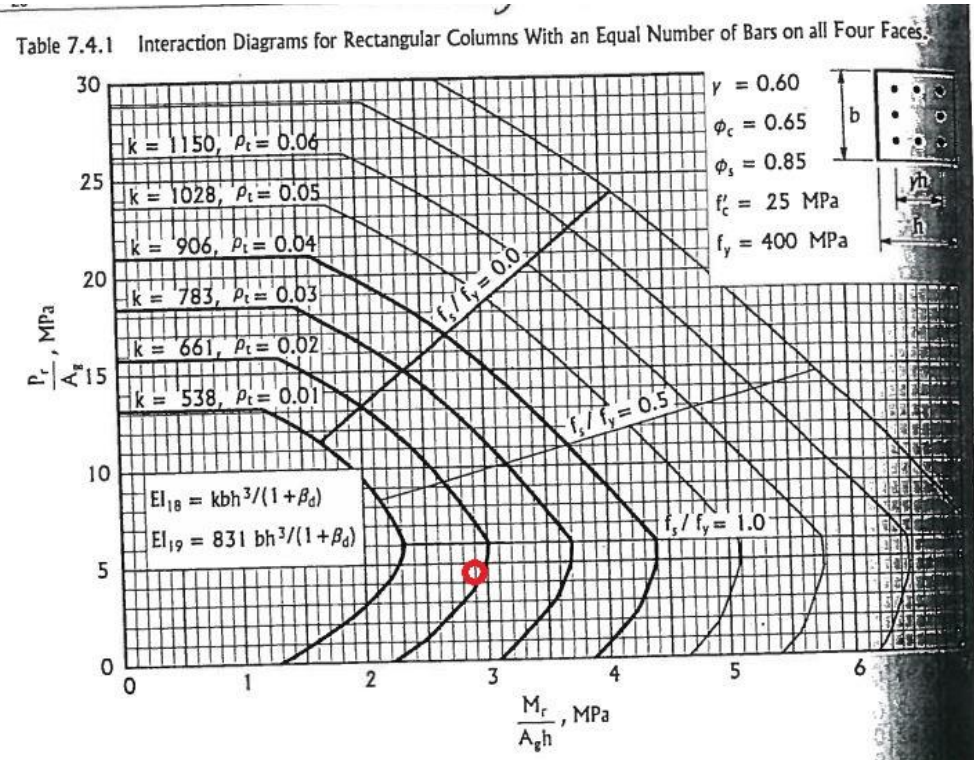

One-way Slab - Ground Floor

Design Summary: 200mm one-way slab, with tension reinf. 15M @ 250mm and temp & shrinkage

Slab Dimensions

| | | |
|------------------|----------|-----------------------------|
| Span | 6.00 m | check if OK with Conc beams |
| Section width, b | 1,000 mm | |
| h | 200 mm | |
| d | 170 mm | h-30mm |

Loading

| | | |
|------------------|------------|-------------------------------|
| Factored Load | 8.33 kPa | from NBCC loading spreadsheet |
| Load per section | 8.33 kN/m | Factored |
| Bending Moment | 37.49 kN-m | Factored |
| Shear | 24.99 kN | Factored |

Material Properties

| | |
|--------|-------------|
| f'c | 25 MPa |
| fy | 400 MPa |
| phi,c | 0.65 |
| phi,s | 0.85 |
| alpha1 | 0.813 |
| Ec | 22,500 MPa |
| Es | 200,000 MPa |

Moment Resistance

| | | |
|------------------|---------------------|--|
| As | 684 mm ² | direct method |
| Ab | 200 mm ² | 15M |
| s | 292 mm | |
| s,trial | 250 mm | try 15M @ 250mm o.c. |
| As,trial | 800 mm ² | |
| rho,trial | 0.0047 | |
| s,max | 500 mm | >s,trial --> OK |
| As,min | 400 mm ² | <As,trial --> OK |
| rho,b | 0.0220 | >rho,trial --> OK, properly reinforced |
| z, crack control | 18,391 N/mm | <30,000 --> OK |
| s,use | 250 mm | use 15M @ 190mm o.c. |
| As,use | 800 mm ² | |
| a | 21 mm | |
| Mr | 43.44 kN-m | >Mf --> OK |

Temperature & Shrinkage Reinf.

| | | |
|--------|------------------------|---|
| As,min | 400.00 mm ² | |
| At | 100.00 | 10M |
| s,max1 | 250.00 | |
| s,max2 | 500.00 mm | |
| s,use | 250.00 mm | use 10M @ 250mm o.c. perp to main tension |

Deflection Check

Height Limits (simplified check) - use this

| | | |
|-------|-------------|-------------------------|
| ln | 5,650.00 mm | assume beams 350mm wide |
| ln/28 | 201.79 mm | =approx 200mm --> OK |

Detailed Calc - for reference

| | | |
|-----|-----------------------------|-------------------------------------|
| Ma | 27.81 kN-m | max bending at unfactored loads D+L |
| n | 8.89 | Es/Ec |
| lg | 666,666,667 mm ⁴ | |
| fr | 3.00 MPa | |
| y,t | 100.00 mm | |

| | | |
|------------------|-----------------------------|--------------------------------------|
| Mcr | 20.00 kN-m | |
| y,bar | 42.57 mm | |
| lcr | 121,900,081 mm ⁴ | |
| le | 324,527,159 mm ⁴ | |
| k, end cond | 1.00 | assume 1 |
| delta, D+L | 14.28 mm | |
| deflection limit | 15.69 mm | CSA A23.3 - Table 9.3 - ln/360 limit |

One-way Slab - Basement Level

Design Summary: 200mm one-way slab, with tension reinf. 15M @ 350mm and temp & shrinkage reinf 10M @ 350mm

Slab Dimensions

| | |
|------------------|----------|
| Span | 5.50 m |
| Section width, b | 1,000 mm |
| h | 200 mm |
| d | 170 mm |

Loading

| | |
|------------------|------------|
| Factored Load | 8.33 kPa |
| Load per section | 8.33 kN/m |
| Bending Moment | 31.50 kN-m |
| Shear | 22.91 kN |

Material Properties

| | |
|--------|-------------|
| f'c | 25 MPa |
| fy | 400 MPa |
| phi,c | 0.65 |
| phi,s | 0.85 |
| alpha1 | 0.813 |
| Ec | 22,500 MPa |
| Es | 200,000 MPa |

Moment Resistance

| | |
|-----------|---------------------|
| As | 560 mm ² |
| Ab | 200 mm ² |
| s | 357 mm |
| s,trial | 350 mm |
| As,trial | 571 mm ² |
| rho,trial | 0.0034 |

| | | |
|------------------|---------------------|--|
| s,max | 500 mm | >s,trial --> OK |
| As,min | 400 mm ² | <As,trial --> OK |
| rho,b | 0.0220 | >rho,trial --> OK, properly reinforced |
| z, crack control | 20,574 N/mm | <30,000 --> OK |

| | | |
|--------|---------------------|----------------------|
| s,use | 350 mm | use 15M @ 190mm o.c. |
| As,use | 571 mm ² | |
| a | 15 mm | |
| Mr | 31.60 kN-m | >Mf --> OK |

Temperature & Shrinkage Reinf.

| | | |
|--------|------------------------|---|
| As,min | 400.00 mm ² | |
| At | 100.00 | 10M |
| s,max1 | 250.00 | |
| s,max2 | 500.00 mm | |
| s,use | 250.00 mm | use 10M @ 250mm o.c. perp to main tension steel |

Deflection Check

Height Limits (simplified check) - use this

| | | |
|-------|-------------|-------------------------|
| ln | 5,200.00 mm | assume beams 300mm wide |
| ln/28 | 185.71 mm | <h=200mm --> OK |

T-Beam - Ground Floor

Design Summary: Concrete T-Beam 400 x 900 @ 6m o.c., with 12 - 30M tension reinf and stirrups 10M @

Beam Dimensions

| | | |
|--------------|----------|--|
| Span, l_n | 16.50 m | spans approx. half the garage width typically? |
| b_w | 400 mm | start with trial |
| h | 900 mm | start with trial |
| Beam spacing | 6,000 mm | |
| l_w | 5,600 mm | |
| h_f | 200 mm | from one-way slab design |
| b_T | 2,400 mm | min. conditions |
| b_f | 5,200 mm | |
| d | 750 mm | start with $h-70$ mm, update with d_{actual} |

Loading

| | | |
|-----------------------|---------------|-------------------------------|
| Factored Load | 9.87 kPa | from NBCC loading spreadsheet |
| Distributed Load | 59.22 kN/m | Factored |
| Bending Moment, M_f | 2,015.33 kN-m | Factored |
| Shear, V_{max} | 488.57 kN | Factored |

Material Properties

| | |
|--------------|-------------|
| f'_c | 25 MPa |
| f_y | 400 MPa |
| $\phi_{i,c}$ | 0.65 |
| $\phi_{i,s}$ | 0.85 |
| α_1 | 0.813 |
| E_c | 22,500 MPa |
| E_s | 200,000 MPa |

Moment Resistance

assume $a < h_f$:

| | | |
|----------------|-----------------------|-------------------------------------|
| $A_{s,direct}$ | 8,121 mm ² | direct method |
| d_b | 30 mm | 30M tension reinf |
| A_b | 700 mm ² | |
| min rebar # | 11.6 | |
| n | 12 | use 12 - 30M |
| rows | 3 | |
| # per row | 4 | |
| d_s | 10 mm | 10M stirrup |
| clear cover | 30 mm | |
| s | 67 mm | |
| s_{min} | 42 mm | $s=67$ --> OK |
| d_{actual} | 748 mm | --> change d above to be similar |
| n_{trial} | 250 mm | try 15M @ 250mm o.c. |
| A_s | 8,400 mm ² | use 12 - 30M |
| ρ | 0.0022 | $A_s/(b_f*d)$ |
| ρ_{b} | 0.0220 | $>\rho$ --> OK, properly reinforced |

T-Beam - Basement Level

Design Summary: T-beam 300x600 w/ 8-25M reinforcement and 10M stirrups spaced at 250mm

Beam Dimensions

| | | |
|--------------|----------|--|
| Span, l_n | 10.00 m | 9No. Columns spaced at 10m at reservoir level |
| b_w | 300 mm | start with trial |
| h | 600 mm | start with trial |
| Beam spacing | 5,500 mm | |
| l_w | 5,200 mm | |
| h_f | 200 mm | from one-way slab design |
| b_T | 2,000 mm | min. conditions |
| b_f | 4,300 mm | |
| d | 515 mm | start with $h-70$ mm, update with d_{actual} |

Loading

| | | |
|-----------------------|-------------|-------------------------------|
| Factored Load | 9.87 kPa | from NBCC loading spreadsheet |
| Distributed Load | 54.29 kN/m | Factored |
| Bending Moment, M_f | 678.56 kN-m | Factored |
| Shear, V_{max} | 271.43 kN | Factored |

Material Properties

| | |
|--------------|-------------|
| f'_c | 25 MPa |
| f_y | 400 MPa |
| $\phi_{i,c}$ | 0.65 |
| $\phi_{i,s}$ | 0.85 |
| α_1 | 0.813 |
| E_c | 22,500 MPa |
| E_s | 200,000 MPa |

Moment Resistance

assume $a < h_f$:

| | | |
|---------------|-----------------------|---|
| $A_s, direct$ | 3,967 mm ² | direct method |
| d_b | 25 mm | 25M tension reinf |
| A_b | 500 mm ² | |
| min rebar # | 7.9 | |
| n | 8 | use 8 - 25M |
| rows | 2 | |
| # per row | 4 | |
| d_s | 10 mm | 10M stirrup |
| clear cover | 30 mm | |
| s | 40 mm | |
| s_{min} | 35 mm | $s < 40$ --> OK |
| d_{actual} | 515 mm | --> change d above to be similar |
| n_{trial} | 250 mm | try 15M @ 250mm o.c. |
| A_s | 4,000 mm ² | use 8 - 25M |
| ρ | 0.0018 | $A_s / (b_f * d)$ |
| ρ_{b} | 0.0220 | $\rho > \rho_b$ --> OK, properly reinforced |

| | | |
|------------------|---------------------|----------------|
| As,min | 450 mm ² | <As --> OK |
| a | 24 mm | <hf=200 --> OK |
| Mr | 684.11 kN-m | >Mf --> OK |
| z, crack control | 19,566 N/mm | <30,000 --> OK |

Shear Resistance

| | | |
|--------------------|---------------------|---------------------------------|
| dv | 464 mm | |
| Factored Live Load | 3.60 kPa | from NBCC loading spreadsheet |
| wf,LL | 19.80 kN/m | |
| Vf,mid | 24.75 kN | |
| Vf@dv | 248.56 kN | |
| Beta | 0.18 | use min shear reinf throughout |
| Vc | 81.34 kN | <Vf@dv --> design shear reinf |
| Vs,req | 167.21 | =Vf@dv - Vc |
| Av | 200 mm ² | use 10M |
| s,req | 270 mm | |
| 0.125... | 282.45 kN | >Vf@dv --> OK, use normal s,max |
| s,max | 324 mm | |
| s,max (Av,min) | 889 mm | |
| s | 250 mm | use 10M @ 250mm |
| Vs | 180.28 kN | |
| Vr | 261.63 kN | >Vf@dv --> OK |
| Vr,max | 564.89 kN | >Vr --> OK |

Deflection Check

Height Limits (simplified check) - use this

| | | |
|-------|--------------|-------------------------|
| ln | 10,000.00 mm | assume beams 350mm wide |
| ln/18 | 556 mm | <600mm --> OK |

Detailed Calc - for reference

| | | |
|------------------|-------------------------------|--------------------------------------|
| Ma | 77.25 kN-m | max bending at unfactored loads D+L |
| n | 8.89 | Es/Ec |
| Ig | 5,400,000,000 mm ⁴ | |
| fr | 3.00 MPa | |
| y,t | 300.00 mm | |
| Mcr | 54.00 kN-m | |
| y,bar | 84.39 mm | |
| Icr | 6,607,989,661 mm ⁴ | |
| Ie | 6,195,370,841 mm ⁴ | |
| k, end cond | 1.00 | assume 1 |
| delta, D+L | 5.77 mm | |
| deflection limit | 27.78 mm | CSA A23.3 - Table 9.3 - ln/360 limit |

Exterior Glulam Columns

Factored Loads

Pf 870 kN (3Vf)

Not eccentrically loaded

Select

265x265mm Glulam Columns (D Fir L. 16c-E)

From tables on P.137 timber HB

Pry 1370

Prx 1370

K_s 0.67 (wet SC)

Pry_red 917.9 kN >870 kN

Prx_red 917.9 kN >870 kN

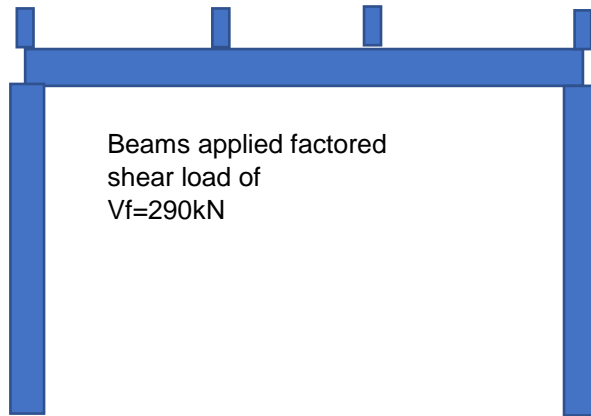

Perimeter Beams

Factored Loads

Vf 290 kN

Mf 580 kN

Select

365x760 D Fir L. 20f-E

289.71

From tables on P 70. timber HB

K_sb 0.8

K_sv 0.87

Vr 333

Mr 810

Vr_red 289.71 >=290kN Acceptable Shear governs

Mr_red 648 >580kN Acceptable

Glulam Beam - Roof

Design Summary: Douglas Fir-Larch 24f-EX Glulam Beam 365 x 950 @ 2m o.c.

Beam Dimensions

| | | |
|--------------|----------------------------|--|
| Span, ln | 16.50 m | spans approx. half the garage width typically? |
| b | 365 mm | start with trial |
| h | 950 mm | start with trial |
| Beam spacing | 2,000 mm | |
| S | 54,902,083 mm ³ | |

Loading

| | | | |
|--------------------|------------|-------------------------------|------------|
| Factored Load | 17.55 kPa | from NBCC loading spreadsheet | |
| Distributed Load | 35.10 kN/m | Factored | 289.575 kN |
| Bending Moment, Mf | 1,194 kN-m | Factored | |
| Shear, Vmax | 289.58 kN | Factored | |

Material Properties

| | | |
|-----|------------|---------------|
| fb | 30.6 MPa | DFir-L 24f-EX |
| fv | 2.0 MPa | DFir-L 24f-EX |
| E | 12,800 MPa | DFir-L 24f-EX |
| phi | 0.90 | |

Modification Factors

| | | |
|-------|------|--|
| K,D | 1.00 | duration factor - standard term |
| K,Sb | 1.00 | service condition factor - dry |
| K,H | 1.00 | system factor - n/a |
| K,T | 1.00 | treatment factor - untreated |
| K,Zbg | 0.81 | size factor <1.3 --> OK |
| K,L | 1.00 | lat stability factor-edge continuously supported w/ peri beams (7.5.6.4.2) |
| K,X | 1.00 | curvature factor - n/a |

Moment Resistance

| | |
|-----|------------|
| Fb | 30.6 MPa |
| Mr1 | 1,229 kN-m |
| Mr2 | 1,512 kN-m |
| Mr | 1,229 kN-m |

Shear Resistance

| | | |
|---------------------------|-----------|------------|
| Vr (P. 70 Wood Design HB) | 416.00 kN | Acceptable |
|---------------------------|-----------|------------|

CLT Roof

| | | |
|---------------------|------------------|-------------------------------|
| Factored Load | 16.3 kPa | from NBCC loading |
| Span | 3 m | check if OK with Glulam beams |
| Section width | 1 m | |
| Load per 1m section | 16.3 kN/m | |
| Bending Moment | 18.3375 kN-m | |
| CLT 5-ply Mr | 36.8 kN-m per 1m | Structurlam CLT, 175V V2M1.1 |

Appendix F: Geotechnical Calculations

| | Centre Wall @ 1m spacing | Perimeter Wall @ 2m spacing |
|--|-----------------------------|--------------------------------|
| Factored Load per length of wall (kN/m) | 1453 | 775 |
| P_i , Factored Load (kN) | 1453 | 1550 |
| Length (m) | 21 | 21 |
| Disturbed length (m) | 1.5 | 1.5 |
| σ (kPa) | 399 | 399 |
| N_q | 20 | 20 |
| f_b (kPa) | 7980 | 7980 |
| A_b (mm ²) | 1600 | 1600 |
| P_b (kPa) | 12.768 | 12.768 |
| β | 0.8 | 0.8 |
| f_s (kPa) | 159.6 | 159.6 |
| A_s (mm ²) | 31.2 | 31.2 |
| P_s (kPa) | 4980 | 4980 |
| P_{ult} (kPa) | 8140 | 8140 |
| P_r (kPa) | 1997 | 1997 |

Appendix G: Project Milestone Schedule

Part 1: April 2017 to November 2017

Spiral Drain System
University of British Columbia

Today's Date: 2018-11-27 Sunday
(weekstart on)

Project Lead: KR
Start Date: 2017-04-01 Sunday

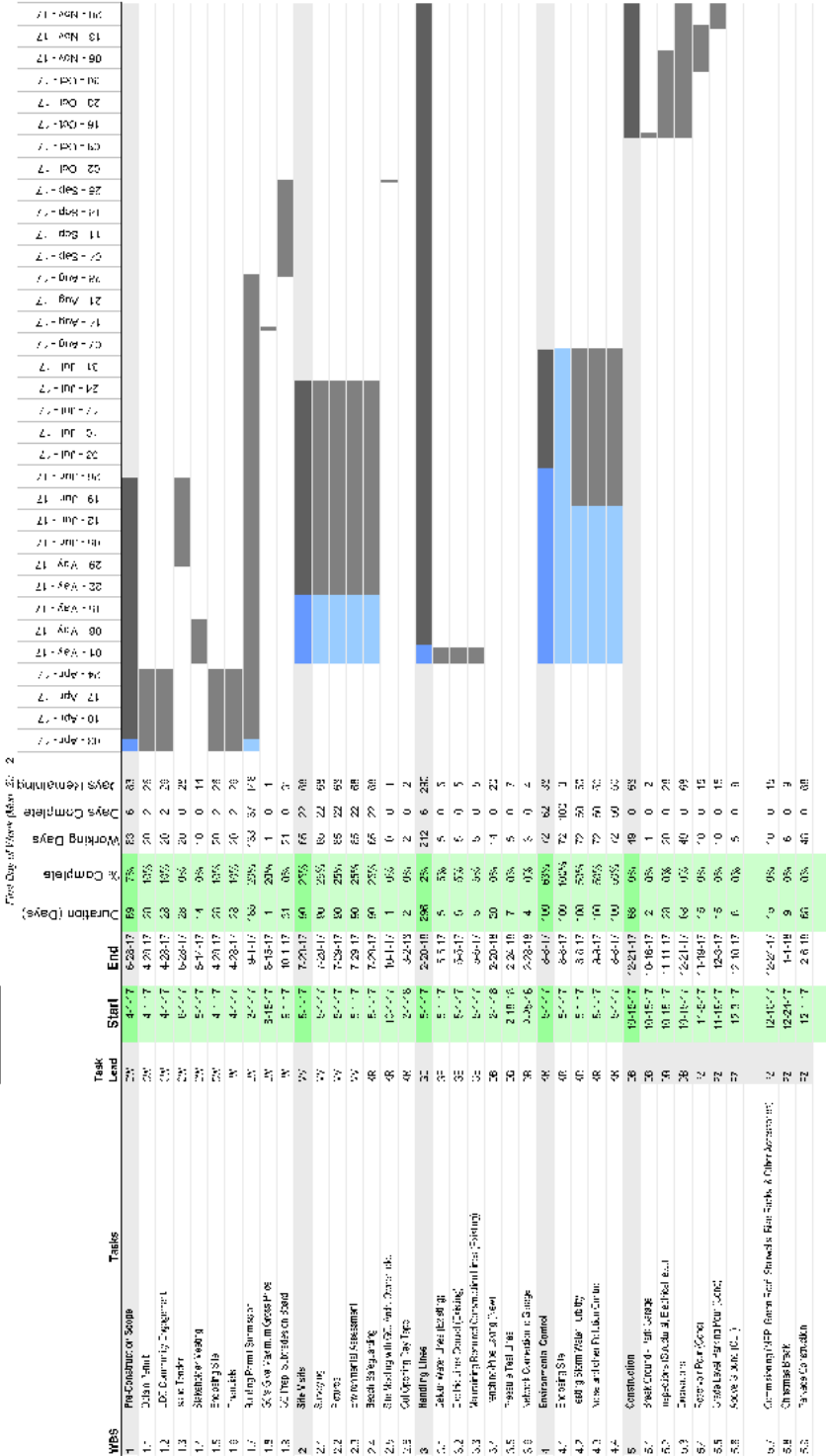

Part 2: December 2017 to March 2018

Spiral Drain System
University of British Columbia

Today's Date: 2018-11-27 Sunday
(vertical red line)

Project Lead: KR
Start Date: 2017-11-20 Monday

| WBS | Task | Task Lead | Start | End | Duration (Days) | % Complete | Working Days | Days Complete | Days Remaining | 18 | 19 | 20 | 21 | 22 | 23 | 24 | 25 | 26 | 27 | 28 | 29 | 30 | 31 |
|-----|-----------------------------|-----------|----------|----------|-----------------|------------|--------------|---------------|----------------|----|----|----|----|----|----|----|----|----|----|----|----|----|----|
| 1 | Pre-Construction Scope | CR | 4-1-17 | 6-21-17 | 20 | 100% | 63 | 6 | 63 | | | | | | | | | | | | | | |
| 1.1 | Obtain Permit | CR | 4-1-17 | 4-28-17 | 26 | 100% | 25 | 2 | 25 | | | | | | | | | | | | | | |
| 1.2 | Site Closure by Engineering | CR | 4-1-17 | 4-28-17 | 26 | 100% | 25 | 2 | 25 | | | | | | | | | | | | | | |
| 1.3 | Site Closure | CR | 8-1-17 | 8-28-17 | 26 | 100% | 25 | 2 | 25 | | | | | | | | | | | | | | |
| 1.4 | Site Worker Access | CR | 8-1-17 | 8-14-17 | 14 | 100% | 15 | 0 | 14 | | | | | | | | | | | | | | |
| 1.5 | Install K-3's | CR | 4-1-17 | 4-20-17 | 20 | 100% | 20 | 2 | 25 | | | | | | | | | | | | | | |
| 1.6 | Install K-3's | CR | 4-1-17 | 4-28-17 | 26 | 100% | 25 | 2 | 25 | | | | | | | | | | | | | | |
| 1.7 | Building for the Submitter | CR | 3-1-17 | 5-1-17 | 155 | 20% | 33 | 37 | 48 | | | | | | | | | | | | | | |
| 1.8 | Construction of the Site | CR | 8-15-17 | 8-15-17 | 1 | 20% | 1 | 0 | 1 | | | | | | | | | | | | | | |
| 1.9 | Construction of the Site | CR | 8-1-17 | 12-1-17 | 31 | 20% | 21 | 6 | 3 | | | | | | | | | | | | | | |
| 2 | Site Works | CR | 8-1-17 | 7-29-17 | 90 | 25% | 85 | 22 | 66 | | | | | | | | | | | | | | |
| 2.1 | Site Works | CR | 8-1-17 | 7-29-17 | 90 | 25% | 85 | 22 | 66 | | | | | | | | | | | | | | |
| 2.2 | Site Works | CR | 8-1-17 | 7-29-17 | 90 | 25% | 85 | 22 | 66 | | | | | | | | | | | | | | |
| 2.3 | Site Works | CR | 8-1-17 | 7-29-17 | 90 | 25% | 85 | 22 | 66 | | | | | | | | | | | | | | |
| 2.4 | Site Works | CR | 8-1-17 | 7-29-17 | 90 | 25% | 85 | 22 | 66 | | | | | | | | | | | | | | |
| 2.5 | Site Works | CR | 8-1-17 | 7-29-17 | 90 | 25% | 85 | 22 | 66 | | | | | | | | | | | | | | |
| 2.6 | Site Works | CR | 8-1-17 | 12-1-17 | 1 | 20% | 0 | 0 | 1 | | | | | | | | | | | | | | |
| 2.7 | Site Works | CR | 8-1-17 | 12-1-17 | 1 | 20% | 0 | 0 | 1 | | | | | | | | | | | | | | |
| 3 | Facilities | CR | 8-1-17 | 2-20-18 | 256 | 23% | 210 | 6 | 290 | | | | | | | | | | | | | | |
| 3.1 | Facilities | CR | 8-1-17 | 2-20-18 | 256 | 23% | 210 | 6 | 290 | | | | | | | | | | | | | | |
| 3.2 | Facilities | CR | 8-1-17 | 2-20-18 | 256 | 23% | 210 | 6 | 290 | | | | | | | | | | | | | | |
| 3.3 | Facilities | CR | 8-1-17 | 2-20-18 | 256 | 23% | 210 | 6 | 290 | | | | | | | | | | | | | | |
| 3.4 | Facilities | CR | 8-1-17 | 2-20-18 | 256 | 23% | 210 | 6 | 290 | | | | | | | | | | | | | | |
| 3.5 | Facilities | CR | 8-1-17 | 2-20-18 | 256 | 23% | 210 | 6 | 290 | | | | | | | | | | | | | | |
| 3.6 | Facilities | CR | 8-1-17 | 2-20-18 | 256 | 23% | 210 | 6 | 290 | | | | | | | | | | | | | | |
| 4 | Environmental Control | CR | 8-1-17 | 5-8-17 | 100 | 100% | 72 | 22 | 35 | | | | | | | | | | | | | | |
| 4.1 | Environmental Control | CR | 8-1-17 | 5-8-17 | 100 | 100% | 72 | 22 | 35 | | | | | | | | | | | | | | |
| 4.2 | Environmental Control | CR | 8-1-17 | 5-8-17 | 100 | 100% | 72 | 22 | 35 | | | | | | | | | | | | | | |
| 4.3 | Environmental Control | CR | 8-1-17 | 5-8-17 | 100 | 100% | 72 | 22 | 35 | | | | | | | | | | | | | | |
| 4.4 | Environmental Control | CR | 8-1-17 | 5-8-17 | 100 | 100% | 72 | 22 | 35 | | | | | | | | | | | | | | |
| 5 | Construction | CR | 10-15-17 | 12-21-17 | 68 | 2% | 49 | 0 | 65 | | | | | | | | | | | | | | |
| 5.1 | Construction | CR | 10-15-17 | 10-16-17 | 2 | 2% | 1 | 0 | 2 | | | | | | | | | | | | | | |
| 5.2 | Construction | CR | 10-15-17 | 12-21-17 | 68 | 2% | 48 | 0 | 65 | | | | | | | | | | | | | | |
| 5.3 | Construction | CR | 10-15-17 | 12-21-17 | 68 | 2% | 48 | 0 | 65 | | | | | | | | | | | | | | |
| 5.4 | Construction | CR | 11-5-17 | 11-19-17 | 15 | 2% | 10 | 0 | 15 | | | | | | | | | | | | | | |
| 5.5 | Construction | CR | 11-19-17 | 12-9-17 | 15 | 2% | 10 | 0 | 15 | | | | | | | | | | | | | | |
| 5.6 | Construction | CR | 12-9-17 | 12-10-17 | 5 | 2% | 5 | 0 | 5 | | | | | | | | | | | | | | |
| 5.7 | Construction | CR | 12-10-17 | 12-21-17 | 15 | 2% | 10 | 0 | 15 | | | | | | | | | | | | | | |
| 5.8 | Construction | CR | 12-24-17 | 1-1-18 | 9 | 2% | 6 | 0 | 9 | | | | | | | | | | | | | | |
| 5.9 | Construction | CR | 12-1-17 | 2-6-18 | 68 | 2% | 48 | 0 | 65 | | | | | | | | | | | | | | |

Appendix H: Project Detailed Cost Estimate (following pages)

Class C Cost Estimate

Parking Garage with Underground Reservoir

| <u>General Project Values</u> | <u>Plan Area</u> | <u>Height</u> | <u>Perimeter</u> |
|-------------------------------|------------------|---------------|------------------|
| Ground Level | 3,120 m2 | 2.3 m | 255.0 m |
| Basement Level | 3,120 m2 | 2.3 m | 255.0 m |
| Reservoir | 3,120 m2 | 2.0 m | 255.0 m |
| Total GFA | 9,360 m2 | 6.6 m | 765.0 m |

| <u>Item</u> | <u>Quantity</u> | <u>Unit</u> | <u>Rate</u> | <u>Factor</u> | <u>\$ Subtotal</u> | <u>\$Total</u> | <u>\$/sqft</u> |
|--------------------------------------|-----------------|-------------|-------------|---------------|--------------------|--------------------|----------------|
| CONSTRUCTION | | | | | | \$9,166,560 | \$90.99 |
| 1. General Construction Costs | | | | | | \$1,211,200 | \$12.02 |
| General Conditions: | | | | | | \$280,200 | \$2.78 |
| Building Permit | 1 | LS | \$10,000 | 1.00 | \$10,000 | | |
| Demolition Permit | 1 | LS | \$5,000 | 1.00 | \$5,000 | | |
| Site Superintendent | 6 | months | \$17,333 | 1.00 | \$104,000 | | |
| Site Assistant Super | 6 | months | \$12,133 | 1.00 | \$72,800 | | |
| Project Manager | 6 | months | \$14,733 | 1.00 | \$88,400 | | |
| Other General: | | | | | | \$931,000 | \$9.24 |
| Bonding | 7,000 | per \$1000 | \$15 | 1.00 | \$105,000 | | |
| Insurance | 7,000 | per \$1000 | \$5 | 1.00 | \$35,000 | | |
| Site offices/vehicles | 6 | months | \$10,000 | 1.00 | \$60,000 | | |
| Site temporary power | 6 | months | \$1,000 | 1.00 | \$6,000 | | |
| Site temporary water | 6 | months | \$1,000 | 1.00 | \$6,000 | | |
| Site toilets | 6 | months | \$1,500 | 1.00 | \$9,000 | | |
| Site security | 6 | months | \$8,667 | 1.00 | \$52,000 | | |
| First Aid station | 6 | months | \$5,000 | 1.00 | \$30,000 | | |
| Small tools | 6 | months | \$10,000 | 1.00 | \$60,000 | | |
| Traffic control | 6 | months | \$15,000 | 1.00 | \$90,000 | | |
| Dump bins | 20 | no | \$1,000 | 1.00 | \$20,000 | | |
| Surveying | 1 | LS | \$20,000 | 1.00 | \$20,000 | | |
| Hoisting - crane | 693 | hrs | \$300 | 1.00 | \$208,000 | | |
| Final cleaning | 1 | LS | \$20,000 | 1.00 | \$20,000 | | |
| Mobilization and Demobilization | 1 | LS | \$150,000 | 1.00 | \$150,000 | | |
| Site manuals | 1 | LS | \$10,000 | 1.00 | \$10,000 | | |
| Miscellaneous | 1 | LS | \$50,000 | 1.00 | \$50,000 | | |
| 2. Excavation | | | | | | \$2,006,757 | \$19.92 |
| Excavation and stockpiling | 29,626 | cy | \$20 | 1.00 | \$592,511 | | |
| Hauling and disposing | 44,438 | tons | \$30 | 1.00 | \$1,333,151 | | |
| Structural fill (gravel?) | 1,244 | cy | \$25 | 1.00 | \$31,095 | | |
| Misc | 1 | LS | \$50,000 | 1.00 | \$50,000 | | |
| 3. Parking Garage | | | | | | \$3,838,759 | \$38.10 |
| Geotechnical: | | | | | | | |
| Standard Penetration Test | 10 | days | \$3,500 | 1.00 | \$35,000 | | |

| | | | | | | | | |
|--|--|---------|------|-----------|------|-------------|--------------------|----------------|
| | Re-analyze Piles | 5 | days | \$500 | 1.00 | \$2,500 | | |
| | Piles and Impact Hammer | 4,242 | m | \$90 | 1.00 | \$381,780 | | |
| | Reservoir Level: | | | | | | | |
| | Concrete slab, foundation, pedestals | 33,583 | sf | \$15 | 1.00 | \$503,739 | | |
| | Concrete foundation wall | 5,489 | sf | \$10 | 1.00 | \$54,895 | | |
| | Basement Level: | | | | | | | |
| | Concrete slab | 33,583 | sf | \$8 | 1.00 | \$268,661 | | |
| | Concrete wall | 6,313 | sf | \$10 | 1.00 | \$63,129 | | |
| | Ground Level: | | | | | | | |
| | Concrete slab | 33,583 | sf | \$8 | 1.00 | \$268,661 | | |
| | CLT wall / Glulam columns | 6,313 | sf | \$15 | 1.00 | \$94,693 | | |
| | CLT roof / Glulam beams | 33,583 | sf | \$15 | 1.00 | \$503,739 | | |
| | Other: | | | | | | | |
| | Mechanical/Electrical/Plumbing | 100,748 | sf | \$13 | 1.00 | \$1,309,721 | | |
| | Finishes | 100,748 | sf | \$3 | 1.00 | \$302,243 | | |
| | Misc | 1 | LS | \$50,000 | 1.00 | \$50,000 | | |
| | 4. Drainage System | | | | | | \$814,650 | \$8.09 |
| | Reroute existing pipes to reservoir | 1 | LS | \$200,000 | 1.00 | \$200,000 | | |
| | 1100mm Concrete Storm Main | 216 | m | \$600 | 1.00 | \$129,600 | | |
| | 750mm Concrete Storm Main | 107 | m | \$450 | 1.00 | \$48,150 | | |
| | Storm Manholes | 3 | no | \$5,000 | 1.00 | \$15,000 | | |
| | 200mm Water Main | 100 | m | \$150 | 1.00 | \$15,000 | | |
| | Fire Hydrant and Valve | 1 | no | \$2,700 | 1.00 | \$2,700 | | |
| | 300mm Sewer Main | 130 | m | \$200 | 1.00 | \$26,000 | | |
| | Sewer Manholes | 1 | no | \$3,200 | 1.00 | \$3,200 | | |
| | Install new pipe system from reservoir to spiral drain | 1 | LS | \$175,000 | 1.00 | \$175,000 | | |
| | Reservoir sensors, equipment | 1 | LS | \$150,000 | 1.00 | \$150,000 | | |
| | Misc | 1 | LS | \$50,000 | 1.00 | \$50,000 | | |
| | 5. Roads and Civil Works | | | | | | \$461,869 | \$4.58 |
| | Entry road | 100 | LF | \$500 | 1.00 | \$50,000 | | |
| | Other civil works | 1 | LS | \$100,000 | 1.00 | \$100,000 | | |
| | Green roof | 16,791 | sf | \$15 | 1.00 | \$251,869 | | |
| | Landscaping | 20,000 | sf | \$3 | 1.00 | \$60,000 | | |
| | TOTAL CONSTRUCTION | | | | | | \$8,333,236 | \$82.71 |
| | Construction contingency | 10% | | | | | \$833,324 | \$8.27 |
| | TOTAL CONSTRUCTION COST | | | | | | \$9,166,560 | |
| | CONSULTANT COSTS | | | | | | \$957,905 | \$9.51 |
| | Architecture and Concept Development | 4.0% | | | | \$366,662 | | |
| | Structural, Civil, Geotechnical Engineering and Design | 3.0% | | | | \$274,997 | | |
| | Drainage Design | 2.0% | | | | \$183,331 | | |

| | | | | | | | | |
|---------------------------|------------------|------|--|--|--|----------|---------------------|-----------------|
| | Landscape Design | 0.5% | | | | \$45,833 | | |
| | Disbursements | 1.0% | | | | \$87,082 | | |
| TOTAL BASE PROJECT | | | | | | | \$10,124,465 | \$100.49 |